

# Masters of Finishing Technology Catalogue



**BINKS**

**DEVILBISS**

**Ransburg**



A leading international business corporation with nearly 100 years of history, Illinois Tool Works Inc. (NYSE: ITW) is a diversified manufacturer of advanced industrial technology. Specifically, we design and produce an array of highly engineered fasteners and components, equipment and consumable systems, and speciality products for customers around the world.

The 825+ decentralised business units that comprise our international business corporation are located in 52 countries and employ approximately 60,000 men and women who are focused on creating value-added products and innovative customer solutions.

ITW's Global Finishing Group has enjoyed considerable growth since the purchase of Ransburg-Gema in 1989, the DeVilbiss Company and Volsatic Inc in 1990 and the acquisition of Binks Manufacturing in 1998.

These companies together with BGK, Evercoat, Hosco, AWC and SprayCore form the ITW Global Finishing Group, a worldwide operation with business units serving the Finishing market.

Focused on spraying and enhancing the sprayed finish of painted surfaces, whilst reducing the release of overspray and VOC's into the atmosphere.





**Binks working in virtually every industry around the world**

In 1890, Joseph Binks pioneered the spray gun industry with the introduction of the first cold-water paint spraying machine. It all started in the basement of Marshall Field & Company, when Joseph Binks figured out how to spray the walls instead of brushing them, and saved a lot of time.



Binks used his invention to rescue the opening of the 1896 Colombian Exposition: Just days before the opening, nine of ten exhibit buildings stood unpainted, but Binks saved the day. Today you can find spray finishing technology from Binks at work in virtually every industry around the world.

**For over 120 years the DeVilbiss philosophy has been finding innovative solutions to spray finishing problems**

Founded in 1888 when Toledo, Ohio physician Dr. Allen DeVilbiss combined a bulb, some tubing, and the base of an oil can to create the first atomiser for health care. DeVilbiss is now the leading supplier of spray finishing equipment to the industrial and automotive refinish markets.



Since then, DeVilbiss has maintained its commitment to innovative technology by establishing itself as a team of experts who thoroughly understand the intricacies of the finishing process, the equipment design needed for achieving the highest quality finish, and the bottom line needs of customers to maximise productivity.

**Ransburg, the acknowledged leader in electrostatic painting processes**

Harold Ransburg developed the first electrostatic application system in 1940 with the introduction of Ransburg No1. Further developments through the 50s and 60s lead to Ransburg achieving material transfer efficiency levels of up to 98% and significant reductions in overspray, resulting in dramatic cost savings and reduced VOC emissions in a wide range of applications, in many different industries.



Today Ransburg is a global brand which plays a vital role in the Binks, DeVilbiss and Ransburg organisation. Ransburg is acknowledged as the market leader in the design and manufacture of electrostatic equipment. Its cutting edge technology has lead to the development of rotary atomisers like bells and discs.

**Innovation**

The culture of Binks, DeVilbiss and Ransburg is rooted in developing commercial innovations. Many of the product success stories begin on-site, where customers' needs are most apparent. Thanks to the expertise of our management and sales force (many of whom are trained engineers) we are well equipped to provide practical and time-sensitive solutions to the most complex situations. The seasoned workforce intimately understands the manufacturing challenges facing customers and can develop original solutions from the ground up.

Binks, DeVilbiss and Ransburg also have the ability to support customers businesses through our world renowned Technology Centre. Working on a request-only basis from any of the 825+ business units, the technology centre provides advanced consulting on issues such as cutting-edge materials, mechanical designs and manufacturing processes.

Our passion for creating commercial innovations is no secret, that's why we typically rank in the top 100 of patent recipients in the United States. In 2007, the company had nearly 20,000 unexpired patents and pending applications worldwide and ranked 79 of top issuers of U.S. patents in 2006.

In addition, each year Binks, DeVilbiss, Ransburg recognise the worldwide patent contributions of our people through the Patent Society. Founded in 1969, the society has 800 members, including hundreds of engineers, technicians and other innovative thinkers employed by us (including hundreds of talented sales people). Nearly 185 of the members are considered Distinguished Fellows, recognised for having patents on inventions for products with noteworthy commercial success, and 21 individuals are Hall of Fame members, distinguished for their lifetime achievement.



## ***TW* Industrial Finishing**

### **Global manufacturing and R&D**

**Facilities are located in Europe, USA, Australia, Brazil, China, Japan and Mexico with long established Industrial Distributors serving all Countries around the World.**

We manufacture and supply all types of Industrial Spray Finishing Equipment and Accessories. Incorporating the world leading Brands of Binks, DeVilbiss and Ransburg producing "cutting edge" high technology Spray Finishing Equipment for the supply and application of all sprayed materials for all major manufacturing Industries and Markets.

This catalogue depicts the range of Binks, Devilbiss and Ransburg Spray Finishing products available from our European sales and marketing operations. This all encompassing product range is itemised in the contents index opposite.

## Contents Index

<b>Introduction to ITW and Index</b>		2-5
<b>Introduction to Manual and Automatic Spray Guns</b>		6-7
Manual Spray Guns	DeVilbiss	8-12
Automatic Guns	DeVilbiss	13-15
Manual/Automatic Airless and Air Assisted Spray Guns	Binks	16-17
<b>Introduction to Electrostatic Spray Guns</b>		18-19
Electrostatic Manual Spray Guns	Ransburg	20-24
Electrostatic Automatic Spray Guns	Ransburg	24-25
Electrostatic Aquapack Systems	Ransburg	25
<b>Introduction to Pumps and Fluid Handling Equipment</b>		26-27
High Pressure Paint Pumps	Binks	28-32
Low Pressure Paint Pumps	Binks	33
Diaphragm Pumps	Binks	34-35
Magic Flow 2K Machine	Binks	36
Air/Fluid Hoses and Connectors	Binks/DeVilbiss	37
Pressure Feed Containers	Binks	38-39
Pressure Feed Cups	Binks/DeVilbiss	39-40
Agitators and Elevators	Binks	40-41
Air Filter Regulators	DeVilbiss	42-43
Fluid Regulators	Binks	44
Air Fed Visors and Masks	DeVilbiss	45
Spray Equipment Accessories	Binks/DeVilbiss	46-47
Spares Kits	Binks/DeVilbiss	48
Spray Booth Filter Paper	Binks	49
Operator Training Support	ITW	50
On-time Deliveries and Keeping You Informed	ITW	51

### Fully Approved Distributors offer the Highest Standards of Sales and Service of Binks, DeVilbiss and Ransburg products throughout Europe.

Our distributors are carefully selected and have met our exacting criteria. To qualify, a Distributor must agree to a comprehensive range of business improvements including: a highly efficient parts and service operation, specialist staff training to ensure expert product knowledge, the provision of technical support and implementation of approved management systems.

#### Proven to be the best

After thorough evaluation of how best to serve our customers, established distributors have proved by far the best method of achieving this goal. Existing Distributors are strategically selected, they understand local industries and their specific finishing requirements. What's more they have the facilities coupled with in-depth product knowledge and experience that we know customers really value.



## Manual and Automatic spray guns...

### DeVilbiss

Manufactures low pressure manual and automatic spray guns and related spraying accessories; including air filter reducing valves and regulators, operator breathing systems, spray gun cups, hoses and other equipment for the Industrial Finishing Markets. DeVilbiss is widely recognised for the development and introduction of the first "Compliant" spray guns, which greatly reduce overspray and VOC's into the environment. An expertise in ergonomics and innovative spray gun design is widely acclaimed.

### Binks

Manufactures low and high pressure manual and automatic spray guns, accessories, airless and air assisted airless spray painting outfits; high and low pressure fluid handing pumps and regulators, pressure feed tanks, 2K electronic paint mixing machines and paint circulating systems for the industrial finishing and automobile manufacturing markets.

A pioneer in spray finishing technology which includes the development and introduction of the world's first "stand alone" HVLP spray guns.

### Leading the way with spray gun Innovation

Binks and DeVilbiss invented the world's first "stand alone" HVLP and COMPLIANT technology spray guns back in the 1980's resulting in a revolution in the way our spray guns atomise paints to provide the bench mark in paint transfer efficiencies saving paint for the end users and dramatically reducing the emission levels of harmful VOC's into the atmosphere. These and other patented ground breaking product developments have placed Binks and DeVilbiss as the foremost spray equipment manufacturer for many years.

## Here is an explanation of the atomising technologies mentioned throughout this section.

### Conventional "Air Spray" Atomisation

The most established method of air atomising used on "conventional" spray guns, uses relatively high velocity compressed air to provide good atomisation of the sprayed material. However this process results in low paint transfer efficiencies due to the 'bounce-back' and 'overspray' generated. Compressed air operating pressures used in this process are typically 2 to 4 BAR (30 to 60 psi).

### HVLP (High Volume Low Pressure)

This "compliant" atomisation method first became important in the 1980's when environmental legislation was first introduced. It uses larger compressed air volumes at lower pressures to atomise the coating. It has a much higher transfer efficiency than Conventional Air Spray. However, the droplet size produced tends to be slightly larger, sometimes resulting in a lower quality finish. HVLP operates at 0.7 BAR (10 psi) at the air cap in compliance with global environmental legislation to provide greater than 65% transfer efficiencies.

### TRANS-TECH® (Compliant)

This atomisation type was introduced by DeVilbiss in the mid 1990's and is a ground breaking combination of Conventional and HVLP atomisation methods. TRANS-TECH utilises more compressed air energy for the atomisation process producing much higher Transfer Efficiency of coating material than the Conventional method. This 'complies' with Global legislation by being able to transfer at least 65% of the sprayed material to the component. Air Cap Pressure is typically 1.3 to 3 BAR (20 to 45 psi). HVLP has mostly been replaced by DeVilbiss TRANS-TECH Atomisation in most applications due to its superior finish qualities.

### Airless Spray

Airless spraying is a method of spray application that does not directly use compressed air to atomise the paint/coating material, hence the terminology "Airless". Hydraulic fluid pressure is used to atomise the paint by pumping it at high pressures of about 30 to 450 BAR (500 to 6500 psi) through a small orifice spray nozzle (typically tungsten carbide) The resulting spray atomisation is ideal for the very fast application of protective and decorative coatings. Typical applications include corrosion protection of large steel components and structures, and the interior of buildings.

### Air Assisted Airless

The paint/coating material is hydraulically forced through a small orifice spray nozzle (tungsten carbide) with a typical fluid pressure of 25 to 120 BAR (400-1800 psi). Final atomisation and fan shaping air is then added by the Binks HVLP/Compliant air cap blending with the fluid stream to produce an exceptionally fine and even spray pattern with very little overspray. This unique combination of Air Assisted Airless/HVLP technologies results in a finely atomised "soft spray" pattern producing a high quality finish that particularly lends itself to finishing wooden products that need an exceptionally fine finish with greatly reduced overspray in compliance with worldwide VOC regulations.

# Innovation and Technical Excellence

## Global Leaders

DeVilbiss and Binks the globally acknowledged leaders in spray gun and air cap design, have pioneered and perfected paint atomisation technology innovations, to ensure the highest possible standards in paint application and finish. The manual and automatic spray guns depicted in this section are evidence of the continual commitment to product excellence from the world leaders in spray gun manufacturing.

## Research and Development

Huge resources are dedicated to research and development. We work closely with the leading paint companies and specialists in surface coatings to ensure our equipment consistently provides the standard of finish our customers demand.

## Atomisation Technologies

DeVilbiss and Binks manual and automatic spray guns utilise Conventional, HVLP, TRANS-TECH Compliant, Airless and Air Assisted Airless atomisation technologies to apply a wide range of industrial coatings. (For a detailed explanation of these technologies see page 6 and for electrostatic technologies page 18).

## Applications

- Aircraft and Aerospace Industry
- Agricultural and Farming Machinery
- Furniture Manufacturers (Wood and Metal)
- General Industry
- Leather Goods and Shoe Makers
- Defence and Military Fighting Vehicles
- Potteries (Glaze)
- Trade Coaters - Stove Enamellers
- Marine and Boating Industry
- Woodworking and Joinery
- Truck and Bus
- Rail and Transport
- Off Road Vehicles – fork lift trucks, plus many others

## Compatible Material/Coating Types

- Solvent and Water Based Materials
- Compliant/High Solids Coatings
- Adhesives
- Primers, Enamels and 2K Polyurethanes
- Fillers, Sealers and Lacquers
- Cellulose
- Pre-Catalysed
- Acid Catalysed
- U.V. Curing Sealers and Topcoats
- Stains and Varnishes
- Release Agents
- Twin Pack Materials (2K)
- Anticorrosive Paints, plus many others

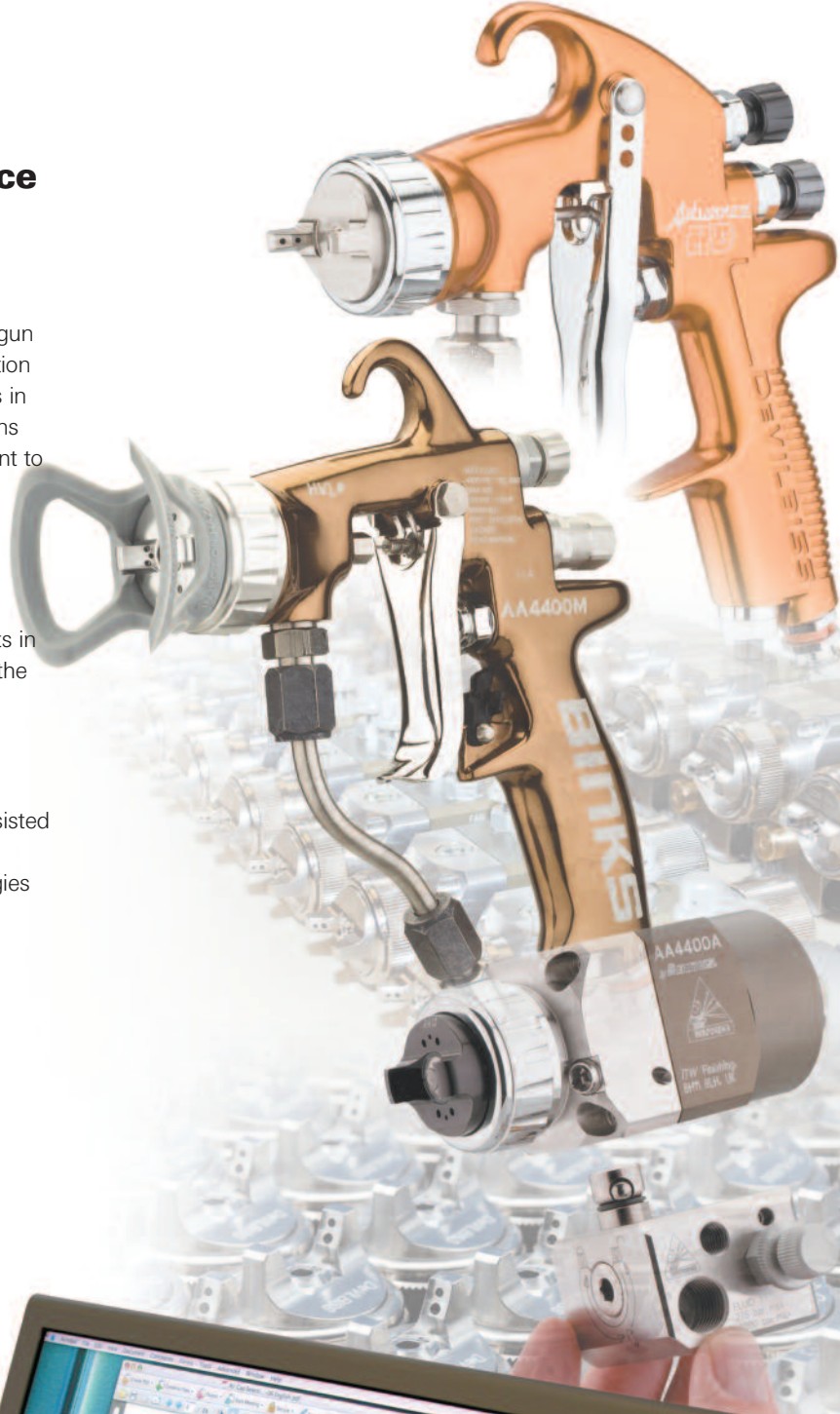

**Manual Spray Guns**

*Advance* **HD**  
by **DEVILBISS**

DeVilbiss spray guns have *Advanced* again with the introduction of a new spray gun range suitable for all Industrial spray applications

**The all purpose mid-sized Compliant spray gun range**

- Robust, Lightweight and work friendly design for *High Demand* outputs
- Balanced air valve design for lighter trigger pull and improved air flow
- TRANS-TECH Compliant and HVLP air caps provide superior finish with the best possible paint savings and transfer efficiency
- Contoured handle design – Greatly reduces RSi and operator fatigue
- Stainless Steel tips, needles and fluid passageways as standard
- CE marked and fully ATEX approved.

The comprehensive Advance HD (*High Demand*) spray gun range ensures there's a DeVilbiss spray gun to suit all types of industrial spray finishing applications. Pressure, Suction and Gravity feed, the Advance HD family utilise a comprehensive, wide range of Compliant Air Caps to provide outstanding coatings' atomisation for handling all types of solvent, waterborne, high solids and 2K materials.

**DeVilbiss expertise and performance unequalled at work...**

Advance HD unrivalled high performance is achieved with new design technology utilising high capacity air passages with a separate "balanced" air valve to provide an unrestricted flow of compressed air through the gun body. This "free breathing" air movement enables the precision-engineered air caps and fluid tips to produce superior atomisation with consistent even distribution throughout the spray pattern. Advance HD is precision built using the best materials and component parts for a guaranteed, reliable, long and durable working life in all industrial markets.

**Advance HD – Naturally comfortable...**

Light weight with a lighter trigger action and increased finger room. Advance HD is perfectly balanced and naturally comfortable thanks to the fit and feel of the contoured handle design. It greatly reduces operator fatigue and significantly lessens the chances of RSi or finger problems. Comfort that pays off by increasing productivity wherever DeVilbiss Advance spray guns are used, whether it's a small finishing operation or a high volume production line.

1 2 3 4 5

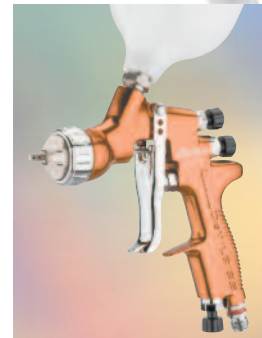

**Key features and benefits of all Advance**



- "TRANS-TECH" Compliant, HVLP or Conventional Air Caps, St St Fluid Tips and Needles with Hardened and tungsten carbide options provide universal compatibility with ALL Industrial Spray Coatings.
- Stainless Steel Fluid passageway/inlet with 3/8" Universal Thread for BSP and NPS compatibility.
- No Baffle design – reduced number of parts, reducing weight and making cleaning easier.

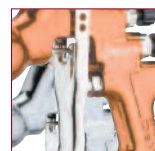

- Increased "Finger" Space – Easier operator access.
- Lighter Trigger Pull Tension – Decreased RSi and Operator Fatigue.
- Self adjusting Needle Packing Assy – PTFE.
- Comfortable operator friendly Trigger design – with reduced trigger travel.

DeVilbiss Advance HD has a very wide selection of fluid and air nozzles to provide outstanding atomisation over a wide range of materials including high solids, solvent/waterborne paints, lacquers, stains, glaze, base and clear coats, twin pack and many other finishing materials.

Example of Advance HD spray gun part numbering:- ADV-P522-14 = ADV = Advance gun / P = Pressure / 522 = TRANS-TECH Air Cap / 14 = 1.4mm Fluid tip and needle. Advance HD spray guns kits are packaged as:- Pressure gun only, Suction gun with 1 litre cup and Gravity feed kits inc. 568 ml standard gravity cup.

Air Cap Number and Type	Air Consumption	Air Inlet Pressure Bar (psi) recommended	*Typical Fluid Flow ml	*Typical Fan Pattern size mm
No. 500R (HVLP)	195 l/min (7 scfm)	1.0 bar (14 psi)	130-190	Round spray
No. 505 (HVLP)	385 l/min (13.6 scfm)	1.3 bar (19 psi)	130-190	270
No. 510 TRANS-TECH	283 l/min (10 scfm)	2 bar (29 psi)	160-220	270
No. 513 TRANS-TECH	394 l/min (14.1 scfm)	2 bar (29 psi)	200-800	350
No. 522 TRANS-TECH	410 l/min (14.5 scfm)	2 bar (29 psi)	200-600	350
No. 523 TRANS-TECH	410 l/min (14.5 scfm)	2 bar (29 psi)	200-400	300
No. 590 TRANS-TECH	218 l/min (7.8 scfm)	2 bar (29 psi)	0-150	150
No. 591 TRANS-TECH	218 l/min (7.8 scfm)	2 bar (29 psi)	0-150	150

No. 505 (HVLP) and No. 500R (HVLP) air caps operate at 0.7 bar (10 psi) at the cap. All illustrated flow rates and fan sizes may vary according to paint/material viscosity and pressures used.

Air Cap No.	Technology	0.5 mm	0.7 mm	0.85 mm	1.0 mm	1.2 mm	1.3 mm	1.4* mm	1.6 mm	1.8* mm	2.0 mm	2.2* mm	2.8* mm
500R	HVLP			P	P	P	P G	P	P G S	P G S	P G S	P G	
505	HVLP			P	P	P	P G	P	P G S	P G S	P G S	P G	
510+	TRANS-TECH			P	P	P	P G	P	P G S	P G S	P G S	P G	
513	TRANS-TECH			P	P	P	P G	P	P G S	P G S	P G S	P G	
522	TRANS-TECH			P	P	P	P	P	P	P	P	P	P
523	TRANS-TECH			P	P	P	P	P	P	P	P	P	P
590	TRANS-TECH	P	P		P								
591	TRANS-TECH	P	P		P								

P = Pressure G = Gravity S = Suction \* Hardened and/or tungsten carbide tips and needles are available in these sizes.



# Manual Spray Guns

## Advance HD by DEVILBISS.

1 2 3 4 5



### The all purpose mid-sized **Conventional** spray gun range

- Wide range of conventional atomisation air caps provide a superior sprayed finish
- Robust, Lightweight and work friendly design for *High Demand* outputs
- Stainless Steel tips, needles and fluid passageways as standard
- Contoured handle design – Greatly reduces RSi and operator fatigue
- CE marked and fully ATEX approved

The DeVilbiss Advance HD (*High Demand*) spray guns are available in Pressure, Suction and Gravity feed formats and a wide range of conventional technology Air Caps provide exceptional atomisation for coating wood, metal, plastic, ceramic and composite substrates with most types of solvent, waterborne, high solids and 2K materials.

### DeVilbiss outperforms the rest

Advance HD's unique high capacity airflow and outstanding atomisation characteristics are combined with a separate "balanced" air valve to provide an unrestricted flow of compressed air through the gun body, this coupled with light, feel right comfort is an unbeatable combination. Advance spray guns are ideal for small operations or high volume spraying, with the added bonus of instantly improved finishing productivity. Advance HD is precision built by DeVilbiss using the best materials and component parts for a guaranteed, reliable, long and durable working life in all industrial markets.



## guns for *High Demand* applications

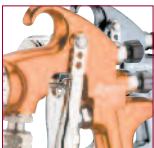

- Forged Aluminium Alloy Gun Body – Heavily Anodised for a Rugged Long working life.
- Wider Hook opening 1/2" (12mm).
- Gun Controls – Easy Adjustment for precise control of Fluid output and atomising air.
- Separate "balanced" Air Valve design for precise air flow triggering and easier cleaning.

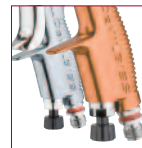

- Curved Handle design – provides superior operator fit and feel with reduced RSi and operator fatigue.
- Air Inlet Adjuster "Cheater" valve included as standard.
- 1/4" Universal Thread air inlet.

**Example of Advance HD spray gun part numbering:-** ADV-P430-14 = ADV = Advance gun / P = Pressure / 430 = Conventional Air Cap / 14 = 1.4mm Fluid tip and needle. Advance HD spray guns kits are packaged as:- Pressure gun only, Suction gun with 1 litre cup and Gravity feed kits inc. 568 ml standard gravity cup.

Air Cap Number and Type	Air Consumption	Air Inlet Pressure Bar (psi) recommended	*Typical Fluid Flow ml	*Typical Fan Pattern size mm
No. 430 Conventional	339 l/min (12 scfm)	3.5 bar (50 psi)	200-280	200
No. 443 Conventional	345 l/min (12.3 scfm)	3 bar (45 psi)	200-300	300
No. 470 Conventional	465 l/min (16.4 scfm)	3 bar (45 psi)	500-1800†	420†
No. 497 Conventional	510 l/min (18 scfm)	3.5 bar (50 psi)	200-600	380

All illustrated flow rates and fan sizes may vary according to paint/material viscosity and pressures used.

† = ceramic material

### Tip and Cap Chart

Air Cap No.	Technology	0.85 mm	1.0 mm	1.2 mm	1.3 mm	1.4* mm	1.6 mm	1.8* mm	2.0 mm	2.2* mm	2.8* mm
430	Conventional	P	P	P	P G	P	P G S	P G S	P G S	P S	
443	Conventional	P	P	P	P G	P	P G S	P G S	P G S	P S	
470	Conventional									P	P
497	Conventional	P	P	P	P	P	P	P	P	P	

P = Pressure G = Gravity S = Suction \* Hardened and/or tungsten carbide tips and needles are available in these sizes.

### Optional accessories for Advance

1. VSA-512 St/St Fluid Filter Kit (inc. 3 elements)
2. Tungsten Carbide and Hardened Tips/Needles (for use on abrasive materials)
3. Nylon Tipped Needle.



Suction cup pt. no. KR-566-1-B



Gravity cup pt. no. GFC 501



Gravity cup (Blue polyester) pt. no. GFC 511 for difficult fluids



# Manual Spray Guns



## DeVilbiss GTi HD – the ultimate in spray gun technology

1 4

Over many years the DeVilbiss GTi range of Compliant spray guns have established themselves as firm favourites with sprayers all over the world. As part of DeVilbiss's continued commitment to be the world leader's in spray gun technology, these iconic spray guns have been completely re-designed and engineered with new gun bodies, air caps, tips, triggers and air valves. Beneath the familiar exterior is the very latest in balanced air management and atomisation technology. These significant product developments once again provide these guns with unrivalled finishing performance and durability.

### The 'full size' Compliant spray gun range

- Renowned DeVilbiss atomisation quality
- TRANS-TECH fully EPA compliant for superior material transfer efficiency and significant paint savings
- High Speed application with consistent lay-down and superior finish
- Balanced air valve design for lighter trigger pull and improved air flow
- Tough, corrosion resistant anodised gun body
- Modular components for easier, faster servicing
- Precision high grade ST/ST fluid tips and needles as standard

Air Cap Number and Type	Recommended Inlet Pressure	Air Flow @ 2 bar/29 psi
T1 TRANS-TECH Gravity/Suction/Pressure	2 bar (29psi)	280 l/min (10 scfm)
T2 TRANS-TECH Gravity/Suction/Pressure	2 bar (29psi)	350 l/min (12 scfm)
T4 TRANS-TECH Pressure	2 bar (29psi)	300 l/min (11 scfm)

SPECIFICATION	GTi HD Gravity	GTi HD Suction	GTi HD Pressure
Air Connection	1/4" Universal	1/4" Universal	1/4" Universal
Fluid Connection	N/A	3/8" Universal	3/8" Universal
Gun Weight (without cup)	585g	650g	650g

Air Cap No.	Tip size	0.85mm	1.0 mm	1.2 mm	1.3 mm	1.4 mm	1.6 mm	1.8 mm	2.0 mm
T1	P	P	P G	G	P G	P S	P S	P S	PS
T2	P	P	P G		P G	P S	P S	P S	PS
T4	P	P	P		P			P	

P = Pressure G = Gravity S = Suction

Example of GTi HD spray gun part numbering:- GTiPHD-T1-10 =

GTiPHD = GTi Pressure Gun HD / T1 = T1 Air Cap / 10 = 1.0 mm Fluid tip and needle.



GTi HD pressure feed spray gun

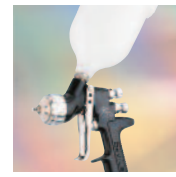

GTi HD gravity gun



GTi HD suction kit



## The Finishing World's favourite spray guns just got better with the introduction of the HD (High Demand) range.

1 4

The DeVilbiss JGA & GFG HD are high performance conventional air atomising guns suitable for most industrial spray finishing applications and are made of the best available materials to withstand the highest demands in the modern spray shop, to provide a guaranteed, long and durable working life. The guns can be used with virtually all industrial solvent and water based paints, coatings, lubricants, dyes, stains, varnishes, lacquers and adhesives.

### The 'full size' Conventional spray gun range

- Renowned DeVilbiss Atomisation Quality
- Genuine fast application rates
- Forged aluminium gun body for long life service
- Light smooth trigger action to reduce operator fatigue
- Balanced air valve design to improve air flow characteristics

Air cap Number and Type	Recommended Inlet Pressure	Air Flow @ 3 bar/43.5 psi
C1 Conventional Gravity/Suction/Pressure	2.5-3 bar (36-44 psi)	250-300 l/min (9-11 scfm)
C2 Conventional Gravity/Suction/Pressure	2.5-4 bar (36-58 psi)	255-400 l/min (9-14 scfm)
C3 Conventional Pressure	2.5-4 bar (36-58 psi)	260-410 l/min (9-15 scfm)

Specifications	JGA HD	GFG HD
Air Connection	1/4" Universal	1/4" Universal
Fluid Connection	3/8" Universal	N/A
Gun Weight (without cup)	650g	585g

Air Cap No.	Tip size	0.85mm	1.0 mm	1.2 mm	1.4 mm	1.6 mm	1.8 mm
C1	P	P	P	P	P G S	P G S	P G S
C2	P	P	P	P G	P G S	P G S	P G S
C3	P	P	P	P	P	P	P

P = Pressure G = Gravity S = Suction

Example of JGA HD spray gun part numbering:- JGAPHD-C3-10 =

JGAPHD = JGA Pressure Gun HD / C3 = C3 Air Cap / 10 = 1.0 mm Fluid tip and needle.



JGA HD pressure feed spray gun

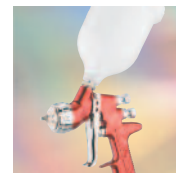

GFG HD gravity gun



JGA HD suction kit



# Manual Spray Guns



## DeVilbiss PRi HD – the ultimate in primer spray gun technology

1 4

The PRi HD is a compliant gravity feed spray gun specifically designed for the application of modern primers, surfacers and fillers. The all new P1 primer air cap incorporates the latest DeVilbiss TRANS-TECH atomisation technology for total compliance with EPA regulations. Primer guns must be compliant in their own right. The P1 air cap is manufactured in plated brass for ultimate durability.

### The all purpose full size Compliant primer spray gun

- Large spray patterns and even material distribution
- Suitable for all types of primers, surfacers, fillers and polyesters
- Air adjuster valve on the gun handle allows instant pressure control
- Balanced air valve design for lighter trigger pull and improved air flow
- Tough and durable drop forged aluminium gun body
- Paint cup includes integral filter and drip-check lid

Air cap Number and Type	Recommended Inlet Pressure	Air Flow @ 2 bar/29 psi
P1 TRANS-TECH Gravity	2 bar (29psi)	300 l/min (11 scfm)

PRi HD Gravity Fluid Tip/Needle (mm) size and code: 1.4, 1.6, 1.8, 2.0, 2.5

Specifications	PRi HD
Air Connection	1/4" Universal
Gun Weight (without cup)	585g

### Example of PRi HD spray gun part numbering: PRIHD-P1-14 =

PRIHD = PRi HD Gravity Gun / P1 = P1 Air cap / 14 = 1.4 fluid tip and needle.



PRi HD gravity kit



## A fine finish spray gun to provide ultra sensitive fan pattern control with the comfort of a full-size spray gun

1 4

The DeVilbiss SRi HD is the ultimate fine finish spray gun providing superb feathering control combined with the pattern range and versatility needed for top quality fine finishing including spot repairs, shading and stencilling, whilst providing excellent comfort stability, balance and delicacy of control.

### Fine finish spray gun

A small scale fine finish spray gun with many practical uses throughout general industry, ergonomically styled for comfort.

- Choice of HVLP or TRANS-TECH® Compliant air caps provide superb atomisation of both solvent and waterbased materials
- Stainless steel fluid tips & needles
- Balanced air valve design for lighter trigger pull and improved air flow
- Lightweight, strong, cast aluminium gun body
- SRi is supplied as standard with a quality screw top gravity feed cup with 125mls. capacity
- Optional inexpensive semi-disposable cups are available

Air cap Number and Type	Recommended Inlet Pressure	Air Flow @ recommended inlet pressure
HS1 HVLP Gravity	2 bar (29psi)	135 l/min (5 scfm)
TS1 TRANS-TECH Gravity	2 bar (29psi)	100 l/min (4 scfm)
RS1 TRANS-TECH Round Spray Gravity	1 bar (15 psi)	55 l/min (2 scfm)

SRi HD Gravity Fluid Tip/Needle (mm) sizes and code: 0.8, 1.0, 1.2, 1.4

SPECIFICATION	SRi HD Gravity
Air Connection	1/4" Universal
Gun Weight (with cup)	500g

### Typical Applications in General Industry

- Fine shading
- Retouching
- Stencilling
- Spot repair
- Reworking

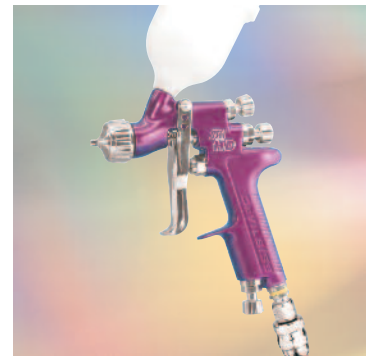

Gravity Cup Part no: SRi-510



Kit contents are spray gun c/w selected air cap and tip set up, gravity cup, pouring funnel, spanner, torx key and cleaning brushes.

### Example of SRi HD spray gun part numbering: SRiHD-TS1-08 =

SRiHD = SRi HD Gravity Gun / TS1 = TS1 Air cap / 08 = 0.8 fluid tip and needle.

### Optional accessories for GTi and JGA guns

VSA-512 St/St Fluid Filter Kit (inc. 3 elements)



Suction cup pt. no. KR-566-1-B



Gravity cup pt. no. GFC 501



Gravity cup (Blue polyester) pt. no. GFC 511 for difficult fluids



# Manual Spray Guns

## FLG5 Manual Spray Gun Range

1 4

- Low cost spray guns for use with a wide range of general industrial paints and materials
- FLG-5 employ DeVilbiss TRANS-TECH® atomisation for paint saving efficiency, superb finishes plus compliance with EPA legislation
- Ultra lightweight, strong, cast aluminium gun body
- Ergonomically shaped gun handle for balance, grip and comfort
- Precision engineered brass air cap and stainless steel fluid tips and needles for long service life

FLG-5 is suitable for most routine spray jobs in the workshop and can also be used by DIY enthusiasts. This budget range of spray guns are available as spray gun kits in Suction and Gravity versions and there is also a Pressure gun option for the larger areas requiring fast coverage without the added down time of re-filling small cups.

The low cost solution: Suction and Gravity guns are supplied in kits.

**Example of FLG5 spray gun part numbering:- FLG5-G5-14 =**  
 FLG5 = model / G5 = Gravity/Air Cap / 14 = Fluid Tip

Air Cap No	Tip Size 1.4mm	Tip Size 1.8mm	Tip Size 2.0mm
No 5 Cap	G	G S	G
No 622 Cap	P		

P = Pressure G = Gravity S = Suction

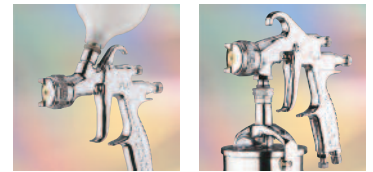

## Digital Air Pressure Adjuster

4 5

- Clear and Accurate DIGITAL Air Pressure Display
- Extremely accurate
- Easy to read
- Very tough
- Solvent resistant
- Zone 0 - intrinsically safe
- Clear and easy to read, just squeeze the trigger and set

Provides accurate control of air pressures on Spray Guns, Paint Pumps, Pressure Tanks and many other finishing products and applications. The DGi Pro digital air pressure gauge by DeVilbiss is a 'Zone 0' approved digital air pressure gauge designed specifically for the spray finishing industry. Engineered by DeVilbiss, the DGi Pro can even be put into the gun wash machine! Accurate and repeatable pressure settings to within .05 bar are assured with the smooth valve action. The DGi Pro is designed to have a service life of two years based on 24 hours a day continuous use.



Part no: DGiPro-502-BAR

## DAGR Airbrush

4

- Hairline detail to high paint-flow shading and gradual fades
- Smooth double action trigger
- Pre-set handle for precise control of paint flow
- Light weight and balanced
- Choice of trigger buttons
- Removable 1/3 oz gravity cup with optional 1/4 oz and 1/2 oz

DAGR sprays most light paints and finishes with excellent control and hairline detail. High paint-flow shading and gradual fades can be achieved. It has a crown design cap to allow fine line work and to protect the needle from accidental damage.

As standard it is supplied with a removable 1/3 fl oz gravity cup and servicing spanner. For really small area work the artist can choose to use no cup at all by filling the reservoir in the airbrush barrel itself.

The airbrush is well-balanced with a smooth, double-action trigger. The solvent proof, PTFE needle packing will not deteriorate with automotive paints. As with all DeVilbiss products, service parts are easily available. A collector's storage tin is included with every DAGR airbrush. DAGR is available from the wide network of DeVilbiss' industrial distributors.

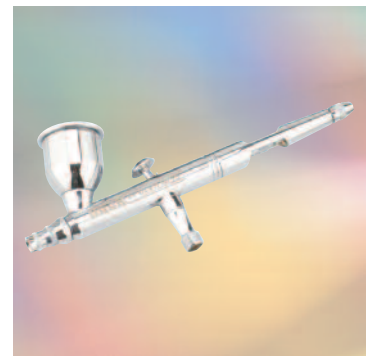

DGR-501G-13 - DAGR Gravity Airbrush .35mm

### DeVilbiss DAGR Specification

Operating Pressure	1.3-3.5 bar (20-50 psi) Maximum
Inlet Pressure	12 bar (175 psi)
Fluid tip	0.35 mm
Cup capacity	9 mls (1/3 fl/oz)
Air hose connection	1/4" NPS (M)
Universal fluid threaded connector	3/8"



# Automatic Spray Guns

## COBRA 1

1 2 4

### DeVilbiss COBRA1

A completely new design of automatic spray gun, purpose made to provide a long working life in tough working conditions. The gun uses the very latest advances in atomising technology to provide users with a cost effective air atomising spray gun with many unique, patented features and benefits.

- Wide range of TRANS TECH (Compliant/HVLP) and Conventional Air Caps provide the best performance on ALL applications
- Removable ST ST Spray Head for fast and easy maintenance
- Control of Spray Performance and fluid flow is unequalled with the Fluid Adjusting Knob (18 indexing positions).
- Stainless Steel – For waterborne and solvent based materials
- Independent Fan, Atomising and Triggering Air – Vital for Robotic and Machine applications
- Indexing Air Cap for consistent reproduction of spray pattern



Part no: CBA1-522-12

**Fluid Tip/needle size and code [mm]** 0.50, 0.70, 0.85, 1.0, 1.2, 1.4, 1.6, 1.8, 2.0, 2.2

**Air Cap code**  
COM-430, COM-443, COM-497, COM-500R, COM-505, COM-510, COM-513, COM-522, COM-523, COM-590, COM-591

## COBRA 2

1 2 4

### DeVilbiss COBRA 2

A highly sophisticated automatic gun that can be detached from its mounting block in a few seconds via the easy thumb release mechanism, for fast and easy maintenance and serviceability. This special feature from DeVilbiss dramatically reduces production downtime. COBRA 2 has all of the above COBRA 1 features plus:-

- Fast and easy removal of the gun from the mounting block provides quick and easy replacement or maintenance with Reduced Production Downtime.

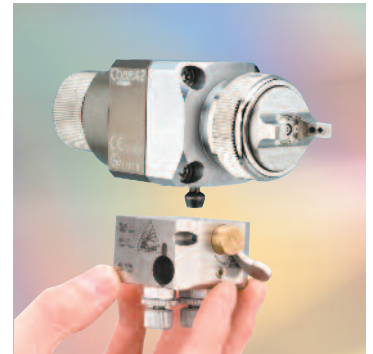

Part no: CBA2-513-14  
Note: The gun head is available separately.

DeVilbiss COBRA Specification		
Air Inlet Fan and Atomising air connection	1/4 BSP female	
Cylinder operating air connection	1/8 BSP female	
Fluid connection	1/4 BSP female	
Fluid recirculation	1/4 BSP female	
Max Air pressure Fan & Atom	"F" & "A" = 7 Bar	
Min to Max cylinder actuating air	4 to 7 Bar	
Max operating ambient temperature	40°C	
Gun weight	Cobra 1 - 720g	Cobra 2 - 950g with mounting block
Length	Cobra 1 - 135mm	Cobra 2 - 118mm
Width	45mm	
Height (with manual adjusting knobs)	COBRA 1 - 63mm	COBRA 2 - 95mm

**Fluid Tip/needle size and code [mm]** 0.50, 0.60, 0.70, 0.85, 1.0, 1.2, 1.4, 1.6, 1.8, 2.0, 2.2, 2.8

**Air Cap code**  
COM-430, COM-443, COM-470, COM-497, COM-500R, COM-505, COM-510, COM-513, COM-522, COM-523, COM-590, COM-591

For further information on the Cobra 1 and 2 Automatic spray guns please refer to the Product Euro Flyer and Service Bulletin.

**Example of COBRA 1 & 2 spray gun part numbering:- CBA1-XXX-YY =**  
CBA1 = gun / XXX = Air Cap /  
YY = Nozzle and needle

#### Air cap and tip selection table for COBRA 1

Type	Conventional			HVLP		TRANS-TECH					
Air Cap No	430	443	497	500R	505	510	513	522	523	590	591
0.5										•	•
0.7										•	•
0.85			•	•	•	•	•	•			
1.0	•	•	•		•	•	•	•	•	•	•
1.2	•	•	•	•		•	•	•			
1.4	•		•	•		•	•	•			
1.6			•	•	•	•	•	•	•		
1.8	•		•			•	•	•			
2.0					•			•			
2.2						•					

#### Air cap and tip selection table for COBRA 2

Type	Conventional				HVLP		TRANS-TECH					
Air Cap No	430	443	470	497	500R	505	510	513	522	523	590	591
0.5											•	•
0.6	•	•				•				•		
0.7											•	•
0.85												
1.0	•	•	•	•	•	•	•	•	•	•	•	•
1.2	•	•	•	•	•	•	•	•	•	•	•	•
1.4				•			•	•	•			
1.6						•	•	•	•			
1.8							•	•	•			
2.2			•	•					•	•		
2.8			•									

# Automatic Spray Guns

## Viper Tungsten Carbide Tips & Needles

1 2 3 5

### Automatic spray gun for the glaze and ceramic industries

- Easy and fast cleaning is provided by the unique and instant 1/4 turn air cap and fluid tip removal system ("Quick'Up" patented)
- Patented "Bellows" assembly protects and reduces spray gun maintenance
- Completely New air cap range for higher transfer efficiency and durability
- Long life with extended serviceability
- Stainless Steel (hardened) and Tungsten Carbide Fluid tips and needles

DeVilbiss Viper is purpose made for the tough working conditions in the Glaze and Ceramics industries.

Fan and air atomising air connection:	1/4 BSP female
Operating air connection:	1/8 BSP female
Fluid connection:	1/4 BSP female
Gun weight:	620g, length 120mm, width 45mm, height 63mm

**NB: Viper is NOT recommended for use with solvent based materials.**

### Air cap and tip selection table (Conventional or TRANS-TECH)

Part no	Nozzle diameter in mm									Technology
	0.7	0.85	1.2	1.4	1.6	1.8	2.0	2.2	2.8	
SPA-100-E31	●	●	●	●	●	●	●			TRANS-TECH
SPA-100-E63						●	●			Conventional
SPA-100-E70								●	●	Conventional

E31 Air Cap (TRANS-TECH) is designed for small to medium flow fluid rate applications with stainless steel "heart" hardened fluid tips. The E31 TRANS-TECH Air Cap is fully compliant with European environmental legislation and is designed to produce the best transfer efficiencies and material savings.

E63 and E70 Air Caps (Conventional) are designed for higher fluid flow rates for use on sanitary ware and ceramic tiles etc.



**Example of VIPER spray gun part numbering:- VPR-XXX-YYC means...**  
 VPR = gun / XXX = Air Cap /  
 YY = Nozzle and needle / C = hard metal



"Bellows System"

## AGN - Automatic spray gun for ceramic and enamel applications

1 5

- Needleless, diaphragm automatic spray gun
- Very Compact and lightweight
- High grade stainless steel and case hardened nitralloy steel Fluid Tips available
- For waterborne application

AGN is a diaphragm operated automatic spray gun for use with ceramic glaze, vitreous enamels, liquid polishing compounds and similar materials. It is ideally designed for continuous applications such as ceramic tile manufacturing. It can also be used with solvent based coatings by fitting a PTFE protective diaphragm.

Air supply atomising	1/4" universal
Diaphragm	6mm push-in tube connector
Coating material supply	3/8" universal
Weight	560g

### Air cap selection table

Part no	Nozzle code and diameter in mm											
	G	FX	FZ	FJ	FF	FW	E	EE	EX	DE	D	AC
	0.7	1.1	1.2	1.3	1.4	1.6	1.8	1.8	1.8	2.0	2.2	2.8
AV-4239-30		●		●	●	●	●		●			
AV-4239-43				●	●	●	●		●			
AV-439-58	●	●		●	●	●	●		●			
MB-4039-62HD												●
MB-4039-64HD										●	●	
MB-4039-67HD								●				
MB-4039-78		●	●	●	●		●					
MB-4039-80				●	●	●	●		●			
AV-4239-186						●						
AV-4239-704	●	●		●	●		●					
AV-4239-705	●	●	●	●	●		●					
AV-4239-765	●	●	●	●	●		●					
AV-4239-777			●	●	●		●					
AV-4239-797			●	●	●		●					



**Example of AGN spray gun part numbering:- AGN-502-YYZ-XX means...**  
 AGN-502 = gun / YY = Nozzle size /  
 Z = Nozzle material (H = stainless steel,  
 N = nitrided steel) / XX = Air cap

## Automatic Spray Guns

### Binks 460 Automatic Spray Gun

1 4

- Aluminium alloy body with plated brass air nozzle
- Stainless steel needle valve and springs
- Gun operation and spray atomisation is controlled from a single air supply
- Control valves for atomisation fan and air flow
- No lag, instant piston controlled "on and off"
- Good range of nozzles for virtually any liquid coatings

The Binks 460 Automatic Spray Gun is a small precision gun designed with accuracy in mind, for ease of fitting to existing automatic and semi-automatic machine. Its small scale dimensions enable the gun to be installed neatly and at close quarters, where the standard range of automatics cannot be accommodated.

#### Air cap selection table (Conventional)

Part no. and code	Nozzle diameter in mm			
	0.5	0.75	1.0	1.5
200831 J92S			●	
200833 J92P	●	●	●	
200838 K92P		●		●



Air and fluid inlet 1/4" BSP  
Fluid passages aluminium

### DeVilbiss AGMD Automatic spray gun

1 2 4

- Exceptional spray performance
- Reduced production down time
- Tried and tested spray application
- Guaranteed repeatability gun set up accurate repeatability
- Low maintenance operator friendly
- Lightweight size and weight
- Sprays all materials industry compatible, St St construction
- TRANS-TECH, HVLP and Conventional Air Cap's

The DeVilbiss AGMD Automatic spray gun with a patented locking device provides a simple and quick change within seconds for servicing and maintenance purposes, this dramatically reduces the production down time. Separate triggering function of fan control air and atomising air. Material circulation and quick flushing through the spray head is possible.

The aircap can be indexed through 90° to provide very positive re-positioning. Sensor inquiry of operating modus (Optional). The AGMD gun is available with a machine adapter or with adapters for all common robots. Suitable for waterborne and solvent based coatings.

Specifications with a machine adapter  
(Example: AGMD + Intermediate Plate AGMD-245-1 + Machine Adapter AGMD-251)

Air cap selection table		
Atom and Fan Air Connection Thread	R 1/8" hose 6 x 8 mm	
Needle Air Connection Thread	R 1/8" hose 4 x 6 mm	
Fluid Connection Thread	R 1/8" hose 6 x 8 mm	
Needle Air Pressure	min. 5.5 bar (53 psi)	
Maximum Air Pressure	9 bar (130 psi)	
Maximum Fluid Pressure	6 bar (87 psi)	
	Complete:	Less Plate + Adapter
Overall Length	116 mm	116 mm
Overall Width	48 mm	46 mm
Overall Height	90 mm	55 mm
Weight	950 gram	665 gram

#### Specification

Part no. XXX	Atomisation Type	Nozzle diameter in mm					
		H 0.5	G 0.7	FX 1.1	FZ 1.2	FF 1.4	E 1.8
AGMD-705	Conventional	●	●	●	●	●	●
AGMD-765	Conventional		●	●	●	●	●
AGMD-765C	Conventional		●	●	●	●	●
AGMD-770	Conventional			●			
AGMD-777	Conventional		●	●	●	●	●
AGMD-797C	Conventional		●	●	●	●	●
AGMD-46C	HVLP			●		●	
AGMD-407-122C	TRANS-TECH			●		●	
AGMD-407-123	TRANS-TECH			●		●	



Part no: AGMD Conventional: AGMD-514  
(followed by fluid tip & set up)

AGMD HVLP/TRANS-TECH: AGMD-515  
(followed by fluid tip & set up)



# Manual Airless and Air Assisted Spray Guns

## AA4400M

2 4

### Air Assisted Airless manual spray gun

The all new Binks AA4400M air assisted airless spray gun has been designed with the operator and environment in mind. This new gun will handle the toughest spray jobs in all industrial markets whilst providing the best fit, feel and comfort operators demand. The spray gun is available with either HVLP or Trans-Tech® air caps operating at lower fluid and air pressures than competitors to achieve an exceptionally fine finish with superior paint savings and lower energy consumption.

#### Spray fan pattern is adjustable on the gun...

- Unique Trans-Tech or HVLP air caps provide a "Softer fine spray" for superior finish quality and higher transfer efficiency than competitors
- Lightweight and Operator friendly design with lighter trigger pull tension
- Easy to remove "in-line" needle assembly for quick maintenance
- Adjustable needle packing and "balanced" air valve design
- Solid forged gun body for maximum durability and longer life
- Stainless steel fluid passages with tungsten carbide seats
- Gun handles Solvent and Waterborne coatings as standard
- Standard flat tip AND Twist tip cleaner available with a wide range of tips from .007" (0.18mm) to .035" (0.89mm)

Specification			
Air and fluid inlet thread	1/4" Universal (M)	Max working pressure	303 bar (4400 psi)
Fluid passageways	Stainless steel	Max air inlet pressure	6.8bar (100psi)
Gun weight	494 gm	Seat	Tungsten Carbide
Gun body	Forged aluminium		

Inline paint filter insert available in two sizes –

\*60 mesh (kit of 5) pt. no. 54-5788-K5 and 100 mesh (kit of 5) pt. no. 54-5789-K5

\*Fitted as standard with all guns.

Part Numbers	
0909-4400-HF0000†	AA4400M Air assisted airless hand gun with HVLP air cap (Flat tip not included)
0909-4400-LF0000†	AA4400M Air assisted airless hand gun with Trans-Tech air cap (Flat tip not included)
0909-4400-HT0000†	AA4400M Air assisted airless hand gun with Twist Tip cleaner & HVLP air cap (no tip)
0909-4400-LT0000†	AA4400M Air assisted airless hand gun with Twist Tip cleaner & Trans-Tech air cap (no tip)

† Order tip separately.

The full range of premium tips, pre-orifice and twist tips for the AA4400M gun are detailed in the Product Euro Flyer and Service Bulletin.



AA4400M gun with HVLP air cap (Flat tip not included)  
Part no: 0909-4400-HF0000



AA4400M gun with Twist Tip cleaner and HVLP air cap (no tip)  
Part no: 0909-4400-HT0000

## Binks Airless Spray Guns

### A3500 & A7500 with 2 or 4 finger triggers

4

#### Choose the gun that is right for you...

- Four finger models offer lower trigger pull and better leverage
- Two finger models provide more control
- 3500 psi packages include: Spray Gun, Tip Guard, (2) 60 mesh Fluid Filters and a Spray Tip
- 7500psi packages include: Spray Gun, Tip Guard, (2) 60 mesh Fluid Filters, (order tip separately)
- Innovative, patent pending valve design eliminates needles and springs
- Tungsten carbide wear parts for long life
- Lower trigger pull and 3-D ergonomic handle reduce fatigue
- Large, long-life filter fills from the inside so it won't collapse
- Long life filter in handle is 20% larger than competitive brands

#### Quick and Easy Disassembly for Cleaning and Maintenance – Less Downtime!

Specifications	
Maximum Fluid Pressure	3500 psi (241 BAR) or 7500 psi (517BAR)
Gun Body	Forged Aluminium
Fluid Path	Anodised Aluminium
Fluid Inlet	1/4" - 18 NPS(m)
Gun Weight	20.5 oz (580 g)

Gun Part Number	Description (guns with twist tips)
1108-3500-2*	3500 PSI Max (241 Bar), 2 Finger Trigger Kit includes: gun/tip guard/9-517-35 Tip and 2 x 60 mesh filters
1108-3500-4*	3500 PSI Max (241 Bar), 4 Finger Trigger Kit includes: gun/tip guard/9-517-35 Tip and 2 x 60 mesh filters
1108-7500-2†	7500 PSI Max (517 Bar), 2 Finger Trigger Kit includes: gun/tip guard and 2 x 60 mesh filters
1108-7500-4†	7500 PSI Max (517 Bar), 4 Finger Trigger Kit includes: gun/tip guard and 2 x 60 mesh filters

\*Includes tip 9-517-35

†order tip separately.

The full range of tips and twist tips are detailed in the Product Euro Flyer and Service Bulletin.



A wide range of Accessories and Airless tips (Flat and Twist tip) including extensions and H.P. swivels are available for these Binks Airless guns



A3500 gun fitted with twist tip cleaner attachment.  
Part no: 1108-3500-2



A7500 gun fitted with twist tip cleaner attachment.  
Part no: 1108-7500-2



# Automatic Airless and Air Assisted Spray Guns

## AA4400A

1 2 4

### Air Assisted Airless HVLP Automatic spray gun

Binks AA4400A is ideally suited for medium to high production multi-gun spray finishing lines. Binks AA4400A combines the best features of HVLP and Air Assisted Airless atomisation to provide a finely atomised "soft spray" to produce the very best spray finish with the highest possible transfer efficiencies, resulting in significant paint savings and compliance with the toughest EPA regulations. AA4400A is a highly sophisticated automatic AAA gun that can be detached from its mounting block in a few seconds via the simple hexagonal key release mechanism, for fast and easy maintenance and serviceability. This unique feature from Binks dramatically reduces production downtime. Binks AA4400A is ideally suited for multi-gun finishing equipment such as rotary machines, reciprocators, robots, fixed and chain-on-edge type systems located in medium to high production environments.

- "Quick detach" head from base for reduced downtime
- Unique air cap design produces "softer fine spray" for superior finishes
- Air cap has optional 15° indexing for precision finishing
- Adjustable "on gun" fan pattern controls
- St St gun head and fluid passages
- Fluid filter in gun head
- Manual or remote gun controls
- Tungsten carbide needle and seat
- Paint re-circ option in head or base plate



### The Best Atomisation and Paint Savings

The unique tip and air cap design of the Binks AA4400A automatic Air Assisted Airless HVLP Spray Gun uses lower fluid and air pressure than competitors guns to achieve exceptionally fine finishes with superior paint savings and lower energy consumption.

### AA4400A is equipped with the AA10HP Air Cap (as standard)

### Example of AA4400A spray gun part numbering:- AA44 X-YY-ZS means...

AA44 = Model /

X = Recirculation: (U = Base/no recirculation; H = Head recirculation) /

YY = Air Cap /

Z = Air controls: M = Manual control fitted; P = Manual controls removed and plugged /

S = Spray gun assembly: B = Spray head + base; G = Spray head only

### Premium tip range : Part No. 114-XXXXX

Fan Width and Size (inches/mm)	2 / 51	4 / 102	6 / 152	8 / 203	10 / 254	12 / 305	14 / 356	16 / 406	18 / 457
.007/0.18	00702	00704	00706	00708	-	-	-	-	-
.009/0.23	00902	00904	00906	00908	00910	00912	-	-	-
.011/0.28	-	01104	01106	01108	01110	01112	01114	-	-
.013/0.33	-	01304	01306	01308	01310	01312	01314	01316	-
.015/0.38	-	-	01506	01508	01510	01512	01514	01516	01518
.017/0.43	-	-	01706	01708	01710	01712	01714	01716	01718
.019/0.48	-	-	01906	01908	01910	01912	01914	01916	01918
.021/0.53	-	-	-	-	02110	02112	02114	02116	02118
.024/0.61	-	-	-	-	02410	02412	02414	02416	02418
.027/0.69	-	-	-	-	02710	02712	02714	02716	02718

	Thread	Pressure
Fluid inlet (1) & fluid recirculation (2)	1/4 NPS Male	Max 276 Bar (4000 psi)
Air inlet Atomising + Fan	1/4 BSP Female	Max 10 Bar (145 psi)
Cylinder/trigger (Cyl)	M5 Female	3 to 10 Bar (45 to 145 psi)
Maximum temperature in use	85° C / 185° F	
Spray gun weight	Complete gun assy 989 gm Gun head 558 gm Gun base assy 431 gm	
Gun body	Aluminium hard anodised	
Fluid passageway/Tip/Needle/Spray head/Base plate	Stainless steel 303 / 17-4 / Tungsten Carbide	
Fluid seals	Viton Extreme, PTFE & Nylon	
Air Flow AA10 Air Cap	5.1 cfm (144 L/min) at 10 psi (0.69 Bar) Cap pressure	
Gun Filter size	150 micron, 100 mesh, 0.006"	

## Model 550 Spray Gun

2 4

For spraying protective coatings such as lacquers, enamels, water based emulsions, mould release agents and sound deadeners. Spray gun equipped with tip guard, stainless steel fluid passages and forged aluminium spray gun body. Actuating air pressure is 40-60 psi. The material body may be installed in any of four positions to facilitate fluid hose connection. Spray nozzle not included, order separately. Mounting hole is 1/2" diameter, furnished with set screw. (Maximum operating pressure is 3000 psi).

Air Inlet	1/4" NPS (m)
Fluid Inlet	1/4" NPS (m)
Weight	680 gm



Part no: 6700-0000-5. Tip not included

## Electrostatic Spray Guns and Equipment...

### Ransburg

Ransburg is the acknowledged global leader in the design, manufacture and marketing of manual and automatic electrostatic finishing products, providing spray finishing solutions to the key industrial and automobile manufacturing markets. Ransburg continues to refine the most efficient electrostatic spray painting technology, delivering a "Class A" finish to each and every customer's product, whilst reducing VOC emissions by providing excellent transfer efficiency and atomisation.

**Binks, DeVilbiss and Ransburg are part of a global finishing group, focused on spraying and enhancing the sprayed finish of painted surfaces.**

### Electrostatic Spraying (Manual Guns)

The Electrostatic technique can be applied to Air Spray, HVLP/Compliant and Air Assisted Airless atomisation spray systems. Ransburg Electrostatic spray guns introduce a high voltage charge into the spray pattern which in turn adds the electrostatic charge into the atomised paint particles. The work-piece is earthed and the attraction between the atomised particles and the work-piece is strong enough to attract the paint/material onto the component with excellent "wrap" characteristics around the back of the work-piece.

Providing very high deposition rates with high transfer efficiency, resulting in greatly reduced paint usage compared to conventional methods in full compliance with worldwide VOC regulations.



# Innovation and Technical Excellence

## Research and Development

Huge resources are dedicated to research and development. Ransburg work closely with the leading paint companies and specialists in surface coatings to ensure our equipment consistently provides the standard of finish our customers demand.

## Technology Led Innovation

Vector SOLO cordless spray gun – Ransburg have reinvented the electrostatic spray gun with the introduction of the Vector SOLO manual spray gun by creating an applicator that operates by compressed air alone. Solo utilises an air driven alternator coupled to a high voltage cascade assembly that is used to generate the electrostatic charge internally, eliminating the need for an external power supply and cable.

This section depicts the all encompassing Ransburg range of manual and automatic electrostatic equipment and accessories for use on most industrial applications.

## Applications:

- Aircraft and Aerospace
- Commercial and off road vehicles including fork lift trucks
- Intricate metal components and wire frames
- Agricultural machines and machinery
- Trailer/Chassis
- Railway engines and carriages including rolling stock
- Trade Coaters
- General metal finishing, plus many others

## Compatible Material/Coating Types

- Solvent and Water Based Paints and Materials
- Compliant/High Solids Coatings
- Twin Pack Materials (2K)
- Metallic Paint
- Lacquers
- Acrylic Paints and Primers
- Enamel Paints
- 2K Polyurethanes, plus many others



## Manual Electrostatic Spray Guns

### VECTOR SOLO

**The new Ransburg Electrostatic Spray Gun that sprays anywhere without electric cables for improved mobility!**

ITW Ransburg the world's leading manufacturer of Electrostatic Spray Technology has re-invented the Electrostatic Spray Gun with the introduction of the Vector SOLO range. Ransburg have re-invented the Electrostatic Spray Gun by creating a gun that operates by compressed air alone utilising an air driven alternator coupled to a high voltage cascade assembly that is used to generate the electrostatic charge internally, eliminating the need for an external power supply and cable.

Ransburg have really "cut the cord" by improving paint atomisation, transfer efficiency, durability and operator comfort with greatly simplified controls that allow the operator to independently adjust the spray fan pattern, fluid flow and the electrostatic effect "on the gun" to give the best possible spray finish, and transfer efficiencies.

A wide range of tips and air caps cover all industrial applications from intricate metal work to spraying an entire aircraft.

**Ransburg SOLO for:-**

- Cordless portability and convenience – No generators or controllers
- Simplified Electrostatic Spraying
- Best Atomisation, Transfer Efficiency and Operator Comfort
- Quick and easy to set up "Straight from the Box"
- Lower running costs and easy maintenance

**Vector Solo Typical Markets and Applications include...**

The Aerospace Industry, General Metal Spraying, Commercial and Off-Road Vehicles, plus many others...



● **Unique internal air driven alternator provides the electrostatic POWER for Solo guns**

**Solo 65kV Electrostatic – Low Pressure Air Spray**

4

The Vector Solo 65kV provides the superior atomisation of the original Vector Solo in a smaller, compact design. Coupling Ransburg's electrostatic technology with a reduced gun size, the Vector Solo 65kV delivers high quality finishes as well as ease of use.

Offering efficiency and portability in one gun, the Vector Solo 65kV is the effective, affordable solution for your finishing operation.

- Reduced Barrel Length... Lightweight, user-friendly design is easily handled
- Ransburg Aircaps... Provide best in class atomisation and superior transfer efficiency
- Low Trigger Pull Force... Reduces operator fatigue improving productivity
- Low Motor Speed... Minimises the vibration transmitted to the handle for a secure grip
- FM and ATEX (CE listed)... Tested and approved for worldwide use in paint booths and in hazardous locations



*Solo 65kV hand gun*

Specifications	
Length	257mm / 10.1 in
Weight	834g / 29.4 oz
Hose Lengths	10m, 15m, 20m, 30m

Electrical	
Operating Voltage	65kV DC (-) Max
Current Output	130 Microamps Max
Paint Resistance	.1M Ohm to Infinity

Mechanical	
Fluid Flow Capability	1000ml/min
<b>Operating Pressure</b>	
Fluid	0-6.9bar / 0-100psi nozzle / material dependant
Air	0-6.9bar / 0-100psi
Ambient Temperature	0-40°C / 32-104°F
Consumption	470 SLPM / 16.6 SCFM @ 2.8bar / 40psi @ the handle inlet
Sound Level	92dB(A) @ 2.8bar / 40psi @ the handle, 1m from the applicator
Vibration Level	.0065m/S2 @ 2.8bar / 40psi @ the handle inlet

# Manual Electrostatic Spray Guns

## Solo 85kV Electrostatic Solvent/Waterborne – Low Pressure Air Spray

4

Keeping with the Ransburg tradition, the Vector Solo Gun delivers superior electrostatic technology in a user-friendly model. With the Vector Solo, ITW Ransburg offers a gun that is not only easy to use but provides best in class atomisation and transfer efficiency.

This 85kV cordless gun has the extra electrostatic power to handle a wider range of materials than the 65kV. With enhanced portability for increased flexibility and movement. Designed to increase user comfort and reduce fatigue, the Vector Solo 85kV also leads to increased productivity for your operation. Ergonomic handle contouring provides the operator proper grip, making extended spray times easier with less fatigue. Requiring less force for trigger pulls and minimising handle vibration, Vector Solo delivers better control and uniform applications.

This versatile electrostatic applicator delivers convenience, consistency and accuracy. Available in either solventborne or waterborne models, the Vector Solo is sure to meet your operation's finishing needs.

- Minimal Air Consumption... Power source requires only 85kV an additional 4 scfm (120 slpm) over a corded applicator

Specifications	
Length	292mm / 11.5 in
Weight	solvent - 880g / 31.0 oz water - 941g / 33.2 oz
Hose Lengths	10m, 15m, 20m, 30m

Electrical	
Operating Voltage	85kV DC (-) Max
Current Output	130 Microamps Max
Paint Resistance	.1M Ohm to Infinity

Mechanical	
Fluid Flow Capability	1000ml/min
Operating Pressure	
Fluid	0-6.9bar / 0-100psi nozzle / material dependant
Air	0-6.9bar / 0-100psi
Ambient Temperature	0-40°C / 32-104°F
Consumption	470 SLPM / 16.6 SCFM @ 2.8bar / 40psi @ the handle inlet
Sound Level	92dB(A) @ 2.8bar / 40psi @ the handle, 1m from the applicator
Vibration Level	.0065m/S2 @ 2.8bar / 40psi @ the handle inlet



Solo 85kV solvent version



Solo 85kV waterborne version

Solo (low pressure air spray) fluid tip range is from 0.028" (0.7mm) to 0.070" (1.8mm) with a choice of fan and round spray air caps.

## Solo AA90 85kV Air Assisted Airless Electrostatic

4

The Vector Solo AA90 combines air-assisted airless technology with proven atomisation in a portable, cordless model. With superior Ransburg electrostatics, this gun delivers advanced spray pattern characteristics, unmatched pattern adjustability and extraordinary transfer efficiency.

Enhanced spray pattern characteristics deliver a precise and consistent application. The Vector Solo AAA's pattern adjustability allows the decrease of overall pattern size, improving accuracy and creating a uniform finish. Ransburg's best in-class atomisation also reduces overspray and paint waste for cost savings.

Vector Solo's cordless design increases flexibility. Operators have a greater range of movement to achieve consistent applications. The superior ergonomic balance improves user comfort and lessens fatigue for an increase in productivity.

Vector Solo AA's efficiency, convenience and versatility helps to lower your bottom line.

- Balanced Electrode Design... Provides the best transfer efficiency in the industry
- Easily Maintained... Modular design makes it easy to repair and replace components, (if needed)
- Single Turn Fan Pattern Adjustment... Reduces overall pattern size by 30%

Specifications	
Length	269mm / 10.6 in
Weight	973g / 34.0 oz
Hose Lengths	10m, 15m, 20m, 30m

Electrical	
Operating Voltage	85kV DC (-) Max
Current Output	130 Microamps Max
Paint Resistance	.1M Ohm to Infinity

Mechanical	
Fluid Flow Capability	1500ml/min
Operating Pressure	
Fluid	0-206.8bar / 0-3000psi tip / material dependant
Air	0-6.9bar / 0-100psi
Ambient Temperature	0-40°C / 32-104°F
Consumption	470 SLPM / 16.6 SCFM @ 2.8bar / 40psi @ the handle inlet
Sound Level	92dB(A) @ 2.8bar / 40psi @ the handle, 1m from the applicator
Vibration Level	.0065m/S2 @ 2.8bar / 40psi @ the handle inlet



Solo AA90 for high pressure atomisation applications.

Solo AA90 has a tip range from 0.009" (0.23mm) to 0.021" (0.53mm) with a choice of fan and round spray caps.

# Manual Electrostatic Spray Guns



## Manual Electrostatic Spray Guns for all Low and High Pressure Applications

Reduced weight and trigger pull with improved ergonomics, all sealing O rings are KALREZ as standard.

### R90 Cascade Electrostatic Solvent/Waterborne – Low Pressure Air Spray

- Conventional air spray
- Reduced overspray - High transfer efficiency
- Modular design - Easy maintenance
- Highly manoeuvrable - Light trigger pull
- Operator friendly - Controls on the gun
- Rugged construction for durability 85kV sprays most types of fluid
- Gun has triple voltage set point adjustment on the gun and voltage on/off on the gun

The system features a patented cascade module located within the spray gun itself. The R90 electrostatic spray gun is designed to apply solvent based coatings with extremely high transfer efficiency. Simple, rugged, reliable, durable, and significantly reduces coating usage and provides maximum uptime.

4



Waterborne version



R90 Cascade Specification			
Length	292 mm	Tip Voltage	85 kV
Weight	635 g	Current	90 $\mu$ A (max)
Operating pressure air	6,9 bar (max)	Fluid delivery	1000 ml/min (max)
Operating pressure fluid	6,9 bar (max)	Atomisation	Conventional Air
Fluid temperature	65°C (max)		

#### Some Typical Applications

Model	Spray Technology	Domestic	Metal & Appliances	Wood Furniture	Tier 1 Car	Aerospace parts	High Voltage	Max kV Generator
R90*	Air Atomising - Low Pressure	●	●	●	●	●	Internal - Cascade	85
R70	Air Atomising - Low Pressure	●	●	●	●	●	Internal - Cascade	65
R90*	Air Atomising - Low Pressure	●	●	●	●	●	External - Classic	85
R70	Air Atomising - Low Pressure	●	●	●	●	●	External - Classic	65

\* Waterborne versions are also available.

### R70 Cascade Electrostatic – Low Pressure Air Spray

Designed for improved access into tight or restricted areas, the R70 is the standard for productions where Class A finishes and high durability are a must. Small compact design is ideal for all painters.

4

R70 Cascade Specification			
Length	254 mm	Tip Voltage	65 kV
Weight	587 g	Current	90 $\mu$ A (max)
Operating pressure air	6,9 bar (max)	Fluid delivery	1000 ml/min (max)
Operating pressure fluid	6,9 bar (max)	Atomisation	Conventional Air
Fluid temperature	65°C (max)		



### R90 Classic Electrostatic Solvent/Waterborne – Low Pressure Air Spray

Designed to apply solvent based coatings with extremely high transfer efficiency. Simple, rugged, reliable and ideally suited to reducing coating usage and providing maximum up-time.

4



Waterborne version



R90 Classic Specification			
Length:	292 mm	Tip Voltage:	85 kV
Weight:	553 g	Current:	90 $\mu$ A (max)
Operating pressure air:	6,9 bar (max)	Fluid delivery:	1000 ml/min (max)
Operating pressure fluid:	6,9 bar (max)	Atomisation:	Conventional Air
Fluid temperature:	65°C (max)		

# Manual Electrostatic Spray Guns

## R70 Classic Electrostatic – Low Pressure Air Spray

4

The R70 is a very light and compact spray gun which can be used in 'very tight' application areas. Wrap around as well as transfer efficiency are excellent which results in significant paint savings.

R70 Classic Specification			
Length	254 mm	Tip Voltage	65 kV
Weight	454 g	Current	90 A (max)
Operating pressure air	6,9 bar (max)	Fluid delivery	1000 ml/min (max)
Operating pressure fluid	6,9 bar (max)	Atomisation	Conventional Air
Fluid temperature	65°C (max)		



## Improved electronic control

The Vector control unit offers the operator 'triple set point' voltage control, plus power on and off, right on the cascade gun. This microprocessor based control allows for data to be collected. This data can then be used to correlate the amount of paint used and parts painted. The illuminated LED display on the control unit is visible at distances of up to 15 metres. External controls can be connected via the integrated connection terminals. Optional multi-position mounting brackets are available.



Technical data	VECTOR R 70 solvent		VECTOR R 90 solvent		VECTOR R90 waterborne coating	
Spray gun model	Classic <sup>1</sup>	Cascade <sup>2</sup>	Classic <sup>1</sup>	Cascade <sup>2</sup>	Classic <sup>1</sup>	Cascade <sup>2</sup>
Order number	79504	79501	79503	79500	79520	79523
Atomisation	Conventional	Conventional	Conventional	Conventional	Conventional	Conventional
Length	24 cm	24 cm	27 cm	27 cm	27 cm	27 cm
Weight	555 g	650 g	620 g	735 g	620 g	735 g
Operating pressure air/fluid	7 bar (100 psi)	7 bar (100 psi)	7 bar (100 psi)	7 bar (100 psi)	7 bar (100 psi)	7 bar (100 psi)
Tip voltage	65 kV	65 kV	85 kV	85 kV	85 kV	85 kV
Max current	140 µA	90 µA	140 µA	100 µA	140 µA	100 µA
Max fluid temperature	65°C	65°C	65°C	65°C	65°C	65°C
Max fluid delivery	1,000 ml/min	1,000 ml/min	1,000 ml/min	1,000 ml/min	1,000 ml/min	1,000 ml/min

High voltage supply <sup>1</sup>external / <sup>2</sup>internal

## AA90 Air Assisted Airless Electrostatic

4

**Vector AA90 is a rugged, yet lightweight Spray Gun designed with the painter in mind.**

The Gun combines superior air-assisted airless atomisation technology with powerful electrostatic features, all in one gun. This integration results in a comfortable, lightweight gun with superior spray pattern characteristics, unmatched 'on gun' fan pattern adjustability with extraordinary high transfer efficiencies. Vector AA90 is available with an extensive selection of air cap and fluid tip combinations to ensure optimum performance is achieved with the coating materials you are using today and in the future.

### Electrostatic power with flexibility

The gun is available in classic or cascade technology able to spray solvent or waterborne coatings. You select the system most suited for your application.

- Classic - The perfect combination of lightweight and simplicity
- Cascade - Designed for those applications where "on the gun" control of electrostatic power output is desired
- "Triple set point" voltage control "on the Cascade gun"
- Spray fan adjustment "on the gun"
- Ultra Lightweight gun with reduced trigger pull tension means reduced operator fatigue
- Solvent and waterborne paint compatibility
- FM and ATEX/CE approved



Vector AA90

### Typical Applications

- General Metal spraying
- Commercial & Off road vehicles
- Aerospace industry
- Truck & Trailers/chassis
- Rail and passenger carriages
- Metal furniture

### Vector AA90 Technical Specification

Spray gun model	Classic	Cascade
Fluid pressure (max)	190 bar (2800psi)	190 bar (2800psi)
Atomisation	Air Assisted Airless	Air Assisted Airless
Length	29.2 cm	29.2 cm
Weight	708 g	793 g
Atomising air pressure (max)	6.8 bar (100 psi)	6.8 bar (100 psi)
Tip voltage	85kV maximum	85kV maximum
Max current	90 µA	90 µA
Max fluid temperature	65°C	65°C
Max fluid delivery	1,000 ml/min	1,000 ml/min



Improved electronic control

1 Tips/needles = Stainless Steel as standard 2 Stainless Steel fluid passageways 3 Optional = Tungsten Carbide and hardened tips/needles

4 Substrate = Wood, metal, plastic and others 5 Substrate = Ceramic and glaze

## Automatic Electrostatic Spray Guns

### No.2 Hand Gun – Pure Electrostatic Rotary Atomisation 4

- “Pure” electrostatic atomisation - highest transfer efficiency
- Tried and tested technology
- Almost no overspray
- 90kV sprays most types of paints and fluids
- “Mobile” outfits available
- 3 bell sizes for all industrial applications
- Air turbine bell rotation

The Ransburg No. 2 gun is the only choice for on-site finishing and the No. 2 electrostatic atomisation spray technology is exclusive to Ransburg. The No. 2 gun offers a superb wrap around and an incredible transfer efficiency of between 95% and 98%.

**Recommended Application:** On-site furniture refinishing and wrought iron.

		Operating pressure:		Atomiser Bell sizes and Fluid delivery:	
Length	508 mm	Tip voltage	90 kV (max)	70mm	(2 <sup>3</sup> / <sub>4</sub> " bell = 75ml/min
Weight	1.588 g	Current	120 µA (max)	100mm	(4" bell = 120ml/min
				180mm	(6" bell = 180ml/min



### Aviator (for REA Cascade Guns only) 4

- Comfortable and easy to handle
- Adjustable voltage for a wide range of settings
- Low air consumption
- The Aviator power unit can be used with Cascade Ransburg hand guns

The Aviator is a power unit which can be used in combination with all Ransburg Vector manual cascade guns and does not need any electric supply. An air operated generator feeds an electronic board located inside of the Aviator housing. The electric output of the Aviator is identical to the 9040 cascade control unit and therefore interchangeable.

Weight	4.500 g	Output voltage	10 V (max)
Minimum air pressure	4,1 bar	Output current	1,2 A
Maximum air pressure	6,8 bar	Sound pressure level	75 dB(A)
Air consumption	225 l/min at 4,1 bar		

ATEX certified for zone 1 (category 2)



### Estaquick Automatic Electrostatic – Low Pressure Air Spray 4

- Gun fits Automatic/Traversing machines
- High output paint flow capability (up to 1000cc/minute)
- Single OR twin pack (2K) material compatibility Independent control of Atomising air, Fan air and Operating air
- Guaranteed spray repeatability - Estaquick Air Caps are accurately located onto the Gun Head to provide consistent spray repeatability
- Quick disconnect fluid tip (1/4 turn bayonet type)

The Estaquick is a quick disconnect electrostatic air atomising spray gun. The spray head is lathered directly in Peek material to make it robust and compatible with all paint materials available in the industry. The gun disconnects for service in less than 5 seconds thanks to an easy 90° turn mounting bracket.

Length	125 mm	Tip voltage	85 kV (max)
Weight	225 g	Current	140 µA (max)
Operating pressure air	7 bar	Fluid delivery	1.000 ml/min (max)
Operating pressure fluid	7 bar (max)	High voltage supply	Classic



### REM Automatic Air Assisted Airless 4

- Flexible cable to the gun
- Allows maximum transfer efficiency with wide range of coating material and part configuration
- Visual verification of voltage on/off
- Safe, reliable with improved field serviceability
- Increased control of spray pattern
- In line replaceable fluid filter

The REM automatic gun applies a high voltage charge to the coating material at the point of atomisation. This electrostatic charge allows a more efficient, uniform application of coating material to the front, edges, sides and back of products, making it highly suitable for applying coatings to a variety of surface configurations, e.g. large targets, small parts, tubular wares, concave and recessed parts.

Length	305 mm	Tip voltage	85 kV (max)
Weight	1.452 g	Current	120 µA (max)
Operating pressure air	6,9 bar (max)	Fluid delivery	1.000 ml/min (max)
Operating pressure fluid	70 bar	High voltage supply	Cascade





## Automatic Electrostatic Spray Guns / Fluid Handling

### Aerobell

4

- Optimum charging of the atomise coating regardless of its electrical conductivity
- Improved pattern control and coating penetration into recessed areas
- Handles all of today's paints, including waterborne and even 100% solid materials
- Fast bell cleaning and quick colour changes
- All external components are constructed of solvent resistant engineered materials to ensure mechanical strength, easy cleaning and non-incendive operation
- Improved operating safety and longer service life even when applying corrosive or erosive paints

The Aerobell is a high speed rotary atomiser which provides excellent transfer efficiency with superior atomisation and the applicator's air bearing turbine provides long life and reliability. The Aerobell handles all of today's paints, including waterborne and even 100% solids (solvent free) materials. The Aerobell is the answer to upgrading your existing bell installation to enhance its safety and performance.

Length	260 mm	Turbine air pressure	0,1 – 3,1 bar	Voltage	100 kV (max)
Weight	5.100 g	Shaping air pressure	6,8 bar (max)	Pattern size	800 mm (max)
Operating pressure fluid	10,3 bar (max)	Break air pressure	6,8 bar nominal	Turbine speed	60.000 rpm (max)
Bearing air pressure	4,1 – 6,8 bar	Fluid delivery	500 ml/min		



### Turbodisc

4

- Handles a wide variety of coatings
- Produces excellent finish uniformity and quality
- Delivers highest transfer efficiency
- Reduces overspray, cleanup and waste disposal
- Reduces VOC emissions and booth exhaust requirements
- Saves labour, energy and materials
- Lowers maintenance requirements.

The Turbodisc rotary paint applicator delivers better atomisation, improved quality and higher transfer efficiency with any of the wide variety of coating materials used in today's production finishing operations. The Turbodisc applicator can be installed as the heart of a new automated system or easily retrofitted to older style, low speed disc systems.



### Ransburg Aquapack Systems

4

Aquapack provides a safe operating system to apply most waterborne materials with the great atomisation and paint savings provided with Ransburg Spray Guns. Ransburg Aquapack's have been specially developed for the safe handling, storage, and supply of water based (high conductivity) paints with Ransburg Electrostatic Spray Guns. High and low pressure versions are available for use with Vector R90 (low pressure) and Vector AA90 (high pressure) spray guns. The entire paint supply and electrostatic control system is housed in a portable Polyethylene cabinet which provides safe handling of W.B. materials.

#### Unique safety feature:

The unit is automatically discharged to earth when the trigger on the gun is released and/or when the cabinet door is opened. These features also deactivate the Electrostatic High voltage during routine cleaning and colour changing.

- Handles most waterborne materials
- Easy to operate and safe
- Mobile and easy to clean
- Low and high pressure outfits available
- Completely assembled, tested and ready for use
- CE approved

**Note:** Aquapack systems can also be used with Solo guns.



Aquapack high pressure system



Aquapack low pressure system

Technical Data	High Pressure/Air Assisted Airless	Air Atomising Low Pressure
Gun	Vector AA90 classic	Vector R90 Classic
Air Pressure	6.9 bar	6.9 bar
Fluid pressure	193 bar (max)	7 bar (max)
Tip voltage	50 kV (max)	85 kV (max)
Current	90 µA (max)	100 µA (max)
Fluid delivery	1.000 ml/min (max)	1.000 ml/min (max)
Pump ratio	32:1	1:1
Paint delivery pump	4,3 l/min (max)	9 l/min (max)
Material	ST ST	Aluminium, anodised
Cabinet height	1.643 mm	1.400 mm
Cabinet width	700 mm	700 mm
Cabinet depth	500 mm	500 mm
Weight	130 kg	100 kg

### Totalizer - Fluid Flow Monitoring/Reporting System

4



The Flow TOTALIZER provides an easy and accurate means of monitoring fluid flow rates and material usage. Now you can monitor the total amount of coating material used per month, per week, per day, by colour, or rate of flow.

### Test Equipment – Multifunction Electrostatic Meter

4



The multi-function electrostatic spray meter uses one meter to serve multi functions in electrostatic spray finishing. The meter can be used to measure conductivity, paint resistance, short circuit current, resistance and high voltage. The meter is available in individual kits focused on each function or a deluxe kit, which includes accessories to perform extra functions.

Part no: 76652-03

## Pumps and Fluid Handling Equipment...

### Binks

Manufactures high and low pressure fluid handling pumps, low and high pressure manual and automatic spray guns, accessories, airless and air assisted airless spray painting outfits, regulators, pressure feed tanks, and paint circulating systems for the industrial finishing and automobile manufacturing markets. A pioneer in spray finishing technology which includes the development and introduction of the world's first "stand alone" HVLP spray guns.

Binks, DeVilbiss and Ransburg are part of a global finishing group, focused on spraying and enhancing the sprayed finish of painted surfaces.

### Binks – years of experience manufacturing the worlds best paint pumps

No other company has more experience and expertise in paint pump technologies used in reciprocating and diaphragm pumps. Binks pumps are not adapted from pumps made for other applications. The pump is at the heart of the paint delivery system, it has to work on demand whenever the spray gun is triggered to deliver smooth surge free paint for the application process.

### Confirmed reliability

We work closely with the leading paint manufacturers to continually evaluate new designs and materials and research customer requirements to develop and improve our pump range. It is this special understanding and dedication to engineering excellence that makes Binks pumps the first choice for industrial markets worldwide.



## Innovation and Technical Excellence

### Plural Component 2K

Binks Magic-Flow is the easy and precise electronically controlled fluid handling plural component mixing system for all types of spray applications with guaranteed accuracy, reliable mixing and metering of two and optional three component materials. Designed as a "Plug and Spray" machine, the Magic-Flow is the best system to ensure repeatability whilst complying with the toughest EPA legislation. Magic-Flow can be utilised with the Binks range of low or high pressure paint pumps along with Binks, DeVilbiss and Ransburg Spray Guns.

### A wide range of fluid handling products, air controls and accessories

The reputation for outstanding reliability and performance is confirmed by the wide ranging industries worldwide that always specify Binks fluid handling products and DeVilbiss air regulator/filters and breathing systems and accessories. Each product has a proven operating pedigree with minimum maintenance and easy parts replacement. They are engineered to exacting standards from the finest materials including the highest grade Stainless Steel for total compatibility with the difficult to handle and water based materials. We leave nothing to chance, which is why we have our own dedicated Spray Booth filter media factory in Scotland.

The Binks and DeVilbiss products depicted in this section of the catalogue include; Air and Fluid Regulators, Operator Air Fed Visors, Air and Fluid Hoses, Pressure Feed Tanks, Paint Agitators and Binks Spray Booth Filter Paper.

### Applications

- Aircraft and Aerospace Industry
- Agricultural and Farming Machinery
- Defence and Military Fighting Vehicles
- Furniture, Woodworking and Joinery
- General Industry
- Leather Goods and Shoe Makers
- Marine and Boating Industry
- Off-road Vehicles and Fork Lift Trucks
- Rail and Transport
- Ship Building and Shipyards
- Truck and Bus
- Trailer/Chassis, plus many others.

### Compatible Material/Coating Types

- Solvent and Water Based Materials
- Compliant/High Solids Coatings
- Adhesives
- Primers, Enamels and 2K Polyurethanes
- Fillers, Sealers and Lacquers
- Cellulose
- Pre-catalysed
- Acid Catalysed
- U.V. Curing Sealers and Topcoats
- Stains and Varnishes
- Release Agents
- Twin Pack Materials (2K)
- Anti-corrosive paints, plus many others.



# High Pressure Paint Pumps



**MAX**imum Durability, Versatility and Ease of use...

2 4

**Binks MX Pumps are a completely new design in pump technology utilising patented magnetic detents to dramatically enhance smooth pump operation and change-over with no pulse to provide the best "surge free" paint delivery for the perfect finish.**

These MX pumps operate at 12:1, 31:1 and 32:1 ratio's with self adjusting spring loaded packings to extend the pump working life cycle and reduce the need for costly maintenance and downtime. The fluid sections and all wetted parts are constructed from the highest quality Stainless Steel for best fluid compatibility whilst providing a long and durable working life. MX pumps are fitted with an operator friendly control panel and include a quality easy to clean fluid filter as standard for reduced tip blockages.

**MX Pump features include:**

- Magnetic detent (patent) for quick stroke change over with no pulse
- Fully Stainless Steel wetted parts and fluid section
- Anti-stall no ice design
- Large sight glass for visual packing inspection
- Solvent cup keeps packings well lubricated
- Self adjusting spring loaded packings
- Divorced pump design – zero potential for paint to enter air motor
- Durable design for heavy duty long working life
- 5 year pump warranty (workmanship and materials)
- CE marked and fully ATEX approved.

**Quality Passport for Binks MX-Pumps:**

Modular construction – Reduced parts – Easy/Fast maintenance – Guaranteed high performance

- All wetted parts are Stainless Steel – Ideal for use with solvent & water based paints/materials
- Fixed, spring tension packing's – Lower maintenance and reduced running costs
- All valve seats are Tungsten Carbide – Long durable working life
- Piston is ultra-hard Chrome plated – Extra wear resistant and longer packing life
- Stainless Steel fluid filter inc. N.R. Valve – Prevents material blockages at the gun tip
- Pump packing's leather and PTFE mix. with option for pure PTFE or UHMWPE – Covers all Industrial applications
- CE marked and ATEX approved for all applications



Choose the Binks MX Pump Outfit for your application from the chart below:

Binks MX Pump outfit	MX 4/12 D-AL	MX 4/12 C-AL	MX 4/12 W-AL	MX 4/12 DB-AL	MX 4/12 P-AL	MX 4/12 D-AC	MX 4/12 C-AC	MX 4/12 W-AC	MX 4/12 DB-AC	MX 4/12 P-AC	MX 4/32 D-AL	MX 4/32 C-AL	MX 4/32 W-AL	MX 4/32 DB-AL	MX 4/32 P-AL	MX 4/32 D-AC	MX 4/32 C-AC	MX 4/32 W-AC	MX 4/32 DB-AC	MX 4/32 P-AC	MX 12/12 C-AL	MX 12/12 W-AL	MX 12/12 C-AC	MX 12/12 W-AC	MX 12/31 C-AL	MX 12/31 W-AL	MX 12/31 C-AC	MX 12/31 W-AC	
MX 4/12 Bare Pump	●	●	●	●	●	●	●	●	●	●																			
MX 4/32 Bare Pump											●	●	●	●	●	●	●	●	●	●	●								
MX 12/12 Bare Pump																						●	●	●	●				
MX 12/31 Bare Pump																										●	●	●	●
High pressure filter assy St St	●	●	●	●	●	●	●	●	●	●	●	●	●	●	●	●	●	●	●	●	●	●	●	●	●	●	●	●	●
Pail Mounted				●					●					●					●										
Tripod Mounted	●			●				●			●			●				●											
Cart Mounted		●					●				●						●							●					●
Wall Mounted			●				●				●						●						●						●
Airless controls	●	●	●	●						●	●	●	●	●					●	●	●				●	●			
Air Assisted Airless controls					●	●	●	●	●							●	●	●	●	●				●	●				●
St St metal suction pipe/filter	●			●	●				●	●				●	●				●	●	●	●	●	●	●	●	●	●	●
Flexible suction hose assy & filter	●	●				●	●				●	●					●	●											
Gravity Hopper (6 litre)			●					●					●					●											

Binks MX pump outfits are fully assembled, tested and ready to spray – Guns and hoses are NOT supplied with these packages:

# High Pressure Paint Pumps

## MX4/12 – Airless and Air Assisted Airless Packages

2 4

Specification			
Ratio	12:1	Max. Operating Pressure	96 bar (1400 psi)
Max. Inlet Pressure	8.0 bar (120 psi)	Cylinder Diameter	55 mm
Flow Rate Nominal	1.5 l/m	Piston Stroke	75 mm
Flow Rate Max.	4.0 l/m	Air Consumption	120/800 l/min
Volume/Cycle	24 cm <sup>3</sup>		

Mounting types available: Pail/tripod/wall/cart and gravity hopper feed.



MX4/12 D-AC tripod mounted AAA outfit

## MX4/32 – Airless and Air Assisted Airless Packages

2 4

Specification			
Ratio	32:1	Max. Operating Pressure	256 bar (3600 psi)
Max. Inlet Pressure	8.0 bar (120 psi)	Cylinder Diameter	85 mm
Flow Rate Nominal	1.5 l/m	Piston Stroke	75 mm
Flow Rate Max.	4.0 l/m	Air Consumption	120/800 l/min
Volume/Cycle	24 cm <sup>3</sup>		

Mounting types available: Pail/tripod/wall/cart and gravity hopper feed.



MX4/32 C-AC cart mounted AAA outfit

## MX12/12 – Airless and Air Assisted Airless Packages

2 4

Specification			
Ratio	12:1	Max. Operating Pressure	96 bar (1390 psi)
Max. Inlet Pressure	8.0 bar (120 psi)	Cylinder Diameter	85 mm
Flow Rate Nominal	4.3 l/m	Piston Stroke	75 mm
Flow Rate Max.	12.0 l/m	Air Consumption	147/450 L/min
Volume/Cycle	72 cm <sup>3</sup>		

Mounting types available: Cart and wall.



MX12/12 W-AC wall mounted AAA outfit

## MX12/31 – Airless and Air Assisted Airless Packages

2 4

Specification			
Ratio	31:1	Max. Operating Pressure	248 bar (3597 psi)
Max. Inlet Pressure	8.0 bar (120 psi)	Cylinder Diameter	140 mm
Flow Rate Nominal	4.3 l/m	Piston Stroke	75 mm
Flow Rate Max.	12.0 l/m	Air Consumption	498/850 L/min
Volume/Cycle	72 cm <sup>3</sup>		

Mounting types available: Cart and wall.



MX12/31 C-AC cart mounted AAA outfit

Guns and hoses are not included in these packages: Select gun/hose packages on page 32.



**MAXimum Paint Saving, Durability and Ease of use...**

**Binks Raptor MAX Air Assisted & Airless pump/gun outfits**

- Five Year pump warranty
- Magnetic detent design (patent) for quick stroke change over with no pulse
- Stainless Steel system – pump and gun
- Low cost spray tip replacement
- Modular design for reduced maintenance & down time
- Lower cost spares prices
- Self adjusting spring loaded packings
- Large sight glass for visual packing inspection

The Binks Raptor MAX range of tripod, cart and wall mounted Pump and Spray Gun packages feature the ALL NEW Binks Stainless Steel MX Pump line equipped with the ALL NEW Binks AA4400M Air Assisted Airless Spray Gun or Binks A3500 Airless Spray Gun. The Raptor MAX outfits have been designed to provide users with a low cost, robust industrial spray outfit, able to apply a wide range of industrial coatings and providing the very best quality of spray finish.

**Raptor MAX Pump Specification**

MX4/12 Ratio 12:1	4 litre per min max fluid delivery	Max operating pressure 96 bar
MX4/32 Ratio 32:1	4 litre per min max fluid delivery	Max operating pressure 256 bar
MX12/31 Ratio 31:1	12 litre per min max fluid delivery	Max operating pressure 248 bar

For further technical specification details please refer to relevant pump service bulletin

**Five year warranty on workmanship and materials on all Binks MX pumps**

**Raptor MAX Packages include:-** Binks MX Pump – Cart, Wall or Tripod mounted • Air and Fluid controls

- 25 litre Suction Hose (Cart and Wall) • 7.5 metre (25') Air (AAA only) and Fluid Hoses • H.P. Fluid Filter
- AA4400M or A3500 (2 trigger) Airless Spray Gun and Tip (Tip size to be specified at time of order)
- Gun mounted Fluid Filter.

Part Number	Mounting type	Technology	Ratio	1 off Gun	Hoses	Fixed tip (inc)
MX-0412T-AAA	Tripod	AAA	12:1	AA4400M	7.5M	Yes
MX-0412C-AAA	Cart	AAA	12:1	AA4400M	7.5M	Yes
MX-0412W-AAA	Wall	AAA	12:1	AA4400M	7.5M	Yes
MX-0412T-A	Tripod	Airless	12:1	A3500	7.5M	Yes
MX-0412C-A	Cart	Airless	12:1	A3500	7.5M	Yes
MX-0412W-A	Wall	Airless	12:1	A3500	7.5M	Yes
MX-0432T-AAA	Tripod	AAA	32:1	AA4400M	7.5M	Yes
MX-0432C-AAA	Cart	AAA	32:1	AA4400M	7.5M	Yes
MX-0432W-AAA	Wall	AAA	32:1	AA4400M	7.5M	Yes
MX-0432T-A	Tripod	Airless	32:1	A3500	7.5M	Yes
MX-0432C-A	Cart	Airless	32:1	A3500	7.5M	Yes
MX-0432W-A	Wall	Airless	32:1	A3500	7.5M	Yes
MX-1231C-AAA	Cart	AAA	31:1	AA4400M	7.5M	Yes
MX-1231W-AAA	Wall	AAA	31:1	AA4400M	7.5M	Yes
MX-1231C-A	Cart	Airless	31:1	A3500	7.5M	Yes
MX-1231W-A	Wall	Airless	31:1	A3500	7.5M	Yes

**Note:** Only these Raptor MAX outfits include guns & hoses as standard.

2 4



Raptor MAX outfits include AA4400M spray gun

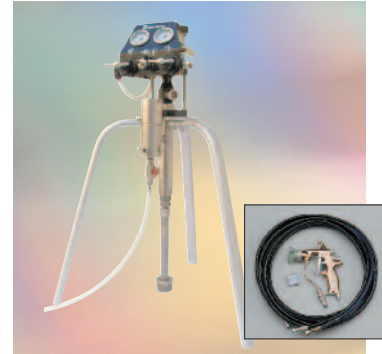

MX-0432T-AAA Raptor MAX tripod mounted outfit with gun, tip and hoses

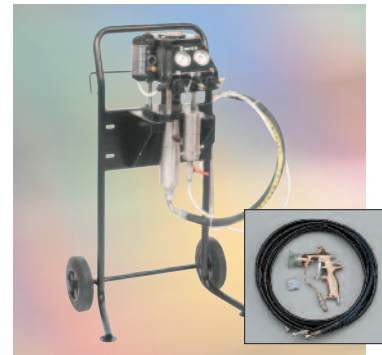

MX-1231C-AAA Raptor MAX cart mounted outfit with gun, tip and hoses



MX-1231W-AAA Raptor MAX wall mounted outfit with gun, tip and hoses

**ST ST High Pressure Heater**

2 4

- Cenelec Approved and CE marked – Approved for "Zone 1 & 2" Hazardous Zone situations
- Tried and tested for Conventional Air Spray, Air Assisted Airless and Airless Spray applications
- Low maintenance with simple operator friendly controls
- Stainless Steel – Suitable for most spray materials
- Size – 420mm (16.5") high X 190mm (7.5") deep X 120mm (4.75") wide
- Temperature range – 16°C to 121°C

Binks High Pressure Stainless Steel Fluid Heaters are fully CENELEC approved and CE marked to provide users with the perfect solution for heated spray applications with operating temperatures from 16 C to 121 C. Specification includes a thermostat and pre-set heat limiter to protect the heating element.

St St Max. WP 5000 psi., 345 Bar – Wall mounting bracket - Part no: 863000



Part no: 830003 – 240V-2kW

## High Pressure Paint Pumps

### BINKS HP Pump Range

- 5 Year Pump Warranty (Workmanship and materials)
- Fully Stainless Steel for use with water and solvent based materials
- Wide Pump Range available – for all markets and applications
- Very Competitively Priced – fast payback
- Tried & Tested design – over many years
- Low Noise levels, Highly efficient and economical air consumption
- Fully Assembled “Ready to Spray”
- “User friendly Controls” – Simple flushing and cleaning
- Manufactured to ISO9000, CE Marked and fully ATEX approved

#### Features & Benefits:

- Hard Chromed Stainless Steel Fluid Sections with Self Adjusting Spring Loaded Packings - Reduced pump down time and Maintenance.
- Pump Packings - Leather/PTFE mix as standard (option for PTFE only)
- Tungsten Carbide Seats
- Dump Valve is integral part of Fluid Filter.

The Binks H.P. Range of Airless & Air Assisted Airless Spray outfits have been designed to provide sprayers with a very competitively priced, robust industrial assembly, able to apply a wide range of industrial coatings whilst providing the very best quality of sprayed finish. Outfits are available from 34:1 up to 66:1 ratio with outputs to suit most industrial applications. These Pumps are matched with Binks Airless and Air Assisted Airless Guns to provide the most versatile, robust, purpose outfits available anywhere today. The outfits are available in cart and wall mounting options. The Pumps are complete with a 5 Year Warranty.

**Three Stage Filtration!** - Stainless Steel Fluid Filter on the Pump outlet is included on all models as standard along with a Gun mounted fluid filter and Suction Hose filter.

2 4



### HP6/34

2 4

Pressure Ratio	Volume per Cycle	Free flow capacity	Operating Pressure max.	Air Consumption
34:1	38 cm <sup>3</sup>	6,0 l/Min	272 bar	120 to 1.200 L/Min

Mount type	Cart Pt. No.	Wall Pt. No.
Airless Outfit	0014-0634F-AL	0014-0634W-AL
Air Assisted outfit	0014-0634F-AC	0014-0634W-AC



HP6/34 cart mounted outfit

### HP25/48

2 4

Pressure Ratio	Volume per Cycle	Free flow capacity	Operating Pressure max.	Air Consumption
48:1	150 cm <sup>3</sup>	25,0 l/Min	384 bar	600 to 2.650 L/Min

Mount type	Cart Pt. No.	Wall Pt. No.
Airless Outfit	0014-2548F-AL	0014-2548W-AL



HP25/48 cart mounted outfit

# High Pressure Paint Pumps

## HP6/60

2 4

Pressure Ratio	Volume per Cycle	Free flow capacity	Operating Pressure max.	Air Consumption
60:1	38 cm <sup>3</sup>	6,0 l/Min	390 bar	120 to 1.200 L/Min

Mount type	Cart Pt. No.	Wall Pt. No.
Airless Outfit	0014-0660F-AL	0014-0660W-AL



HP6/60 wall mounted outfit

## HP20/66

2 4

Pressure Ratio	Volume per Cycle	Free flow capacity	Operating Pressure max.	Air Consumption
66:1	115 cm <sup>3</sup>	18,5 l/Min	429 bar	600 to 2.650 L/Min

Mount type	Cart Pt. No.	Wall Pt. No.
Airless Outfit	0014-2066F-AL	0014-2066W-AL



HP20/66 cart mounted outfit

Note: All Binks H.P. Pump outfits exclude Gun & hoses etc. (Except Raptor Max outfits).

### HP Pump Outfit Airless - includes:-

Pump Assembly Includes	HP 6/34	HP 25/48	HP 6/60	HP 20/66
Filter	Type 3	Type 11	Type 11	Type 11
Filter Suction System	59 mm	59 mm	140 mm	140 mm
Pressure Regulator	1/2"	R 1" Combi	R 1" Combi	R 1" Combi
Suction Hose System Cart/Wall	NW 20	NW 25	NW 20	NW 25
Suction Hose System Tripod/Pail	NW 20	-	-	-

### HP Pump Outfit AAA - includes:-

Pump Assy Includes	HP 3/28	HP 6/34
Filter	Type 1	Type 3
Filter Suction System	59 mm	59 mm
Pressure Regulator	AC 3/8"	AC Regulator
Suction Hose System Cart/Wall	NW 13	NW 20
Suction Hose System Tripod/Pail	NW 9	NW 20

### Accessories

HP Outlet Filter Type	Part Number
Type 1	0114-013525
Type 3	0110-009130
Type 11	0114-011760



Suction Hose assembly	Pt. No.
NW 9 Tripod	0114-014682
NW 9 Pail	0114-014684
NW 13	0114-018933
NW 20 Tripod	0110-011726
NW 20 Pail	0114-016023
NW 20 Cart/Wall	0114-014844
NW 25	0114-013563



Air Regulators	Pt. No.
Airless 3/8"	0114-013531
Airless 1/2"	0110-009348
AAA/AC 3/8"	0114-009350
AAA/AC 1/2"	0110-011745
R 1" Combi	0114-016033

Further Accessories available • Repair Kit (Air Motor / Material Pump) • Seal Kit (Air Motor / Material Pump). See the HP Pump Service Bulletin.

### Airless and Air Assisted Airless gun/hose/tip packages

Part number for gun/hose/tip kits - for use with standard Binks MX & HP pump outfits:

- AA4400M-75** AA4400M Air Assisted Airless Spray Gun with air cap, tip and 7.5 metre Air/Fluid Hose
- A3500-2-75®** A3500 Airless gun with 2 finger trigger with twist tip attachment, tip and 7.5 metre Airless Hose
- A3500-4-75®** A3500 Airless gun with 4 finger trigger with twist tip attachment, tip and 7.5 metre Airless Hose
- A7500-2-75\*** A7500 Airless gun with 2 finger trigger with twist tip attachment (no tip) and 7.5 metre Airless Hose
- A7500-4-75\*** A7500 Airless gun with 4 finger trigger with twist tip attachment (no tip) and 7.5 metre Airless Hose

®Supplied with tip 9-517-35 \*Order tip separately



Part No: A4400M-75 gun, hose and tip package



Part No: A3500-2-75 gun, hose and twist tip package (inc. tip)



Part No: A7500-2-75 gun, hose and twist tip package (no tip)



# Low Pressure Paint Pumps

## EXEL Pumps

2 4

Designed to meet the industry's demand for durability and dependability

- Low Air Consumption - At approximately the same rate of air consumption, EXEL pumps can deliver significantly more fluid than other horizontally opposed piston or diaphragm pumps
- Simple maintenance, easily accessible for parts replacement
- Self-priming
- Choice of Aluminium or Stainless Steel wetted parts
- Hard chrome plated Stainless Steel pistons with pressure loaded wiper seals means longer life with less maintenance
- Can be floor, wall or drum mounted.

The unique design of the pumps allows them to run for very long periods with virtually no maintenance or downtime. Designed for durability, EXEL pumps last longer and require less maintenance than other horizontally opposed pumps. Typical fluids handled by the EXEL pumps include catalysed coating, high solids coatings, abrasive materials, solvent and waterborne fluids, moisture sensitive materials, and UV-cure coatings. Typical applications include air spray and HVLP supply pumps, circulating systems.



Part no: Stainless Steel model 41-38045

Specification	
Ratio	4.5:1
Max. Cycle rate	60 cycles/min
Max fluid delivery	26 litres/min (6.85 GPM)
Max air inlet pressure	6.8 bar (100 PSI)
Air motor diameter	7 1/4"
Air consumption/ 60cycle @ 100psi	793 litres/min (28SCFM)
Air inlet size	1/2"NPS (f)
Fluid inlet size	1"NPT (f)
Fluid outlet size	1"NPT (f)

## LP10/4 Low Pressure Paint Pump

2 4

- Simple handling – Wall & Cart options
- Reliable and low-maintenance – tried and tested design
- Easy to clean
- Stainless Steel Fluid Section for waterborne compliance
- "Open" packing design with easy packing adjustment
- 5 year ITW Warranty (workmanship and materials)

The LP10/4 is an air operated piston pump designed for low to medium production rates with an operating ratio of 4.3:1. Constructed from the best available materials to provide compatibility with a wide variety of industrial paints and spray materials. LP10/4 is available as a bare pump and also as fully assembled wall and cart mounted outfits.

LP10/4 Specification			
Ratio	4.3:1	Max. Operating pressure	20 bar
Max. inlet pressure	5 bar	Cylinder Diameter	70 mm
Flow Rate	9.1 L.P.M. max	Piston Stroke	75 mm
Flow Rate nominal	2.26 L.P.M.	Air Consumption	66 to
Volume/Cycle	151 cm		332 L/min max



Part no: 0114-016064  
– Bare Pump (25 litre)

## Infinity "Pogo" Pumps

2 4

- Wetted Materials: Stainless Steel or Carbon steel
- UHMW polyethylene packing set
- Bung mount
- Stub version for wall mount
- Pressure ratio: 2:1

Infinity "Pogo" - The Binks original drum transfer pump. 55 gallon drum pump also available in a stub pump version.  
Fluid delivery (max) 15.1L/min (4 US gallons per minute).



Part no: 812300 (SS) ball pump  
Part no: 812304 (SS) stub pump  
Part no: 812302 (carbon steel) stub pump

# Diaphragm Pumps

## Infinity Diaphragm Pumps

4

### Binks Infinity The Best PUMP for ALL kinds of Finishing Applications

- Stainless steel seats on all pumps
- Stainless steel or PTFE balls available on most pumps
- "Unstallable" unbalanced air valve design eliminates stalling problems
- Does not require lubrication in most applications
- Uses significantly less air than the competition and is forgiving in dirty air
- Air motor valve designed to apply constant air pressure to both the pilot and major shift valves to enhance performance and reduce pulsation
- Positive prime instant start ups
- Pressure ratios include 1:1 and 3:1

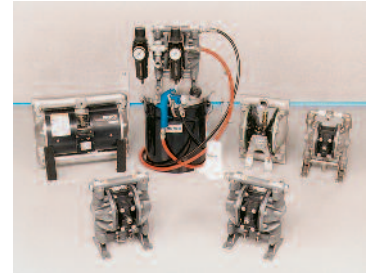

The Infinity range of Diaphragm Pumps

### Five year warranty on workmanship and materials on all Binks Infinity pumps

Binks Infinity diaphragm pumps are the best choice for abrasion, solids handling, and shear sensitive materials. The Infinity series is ideal for the reliable and affordable spray or transfer of low pressure, high volume coatings. The pump will not be damaged in the event that the fluid supply has become depleted. Infinity supports one to multiple spray guns and bulk transfer applications.



Binks Infinity Acetal Pump

### Infinity Diaphragm Pumps range and options

Size (inches)	Flow Litres p/min	Flow gpm	Wetted	Diaphragm	Balls	Seats	Part numbers:			
							Bare	Wall	Bung	Pail
1/2	26.5	7	PP	SANT*	SANT*	SS	818835	-	-	-
1/2	26.5	7	GND ACT	PTFE	SS	SS	818831	-	-	818160
1/2	26.5	7	SS	PTFE	SS	SS	818834	-	-	-
1/2	49.2	13	PP	SANT*	SANT*	SS	818832	-	-	-
1/2	49.2	13	GND ACT	PTFE	SS	SS	818836	-	-	-
1/2	49.2	13	SS	PTFE	SS	SS	818830	818150	818170	-
1/2	49.2	13	PP	PTFE	SS	SS	818833	-	-	-
1	133	35	PP	PTFE	SS	SS	818840	-	-	-
1	133	35	ALUM	PTFE	SS	SS	818820	818120	-	-
1	133	35	SS	PTFE	SS	SS	818822	818122	-	-
1 (3:1)	90.8	24	SS	PTFE	SS	SS	818850	818100	-	-
1 1/2	378	100	SS	PTFE	PTFE	SS	818810	818110	-	-

5 \*NB: 1/2" pumps with 'SANT' diaphragm and balls are suitable for ceramic applications.

Key:	
SS	= Stainless Steel
GND ACT	= Groundable Acetal
PP	= Polypropylene
SANT	= Santoprene

# DVP Pumps

## DVP – 1:1 Ratio Diaphragm Pumps and Outfits

4 5

The DVP is a high specification, air powered 1:1 ratio Diaphragm Pump developed for the direct supply of paints and materials to Spray Guns.

The design ensures a constant and virtually pulse free fluid delivery for direct feed to Spray Guns without the expense and complications of a fluid regulator or surge chamber.

The DVP range features bare pumps, assembled pump packages and complete "ready to spray" outfits matched with the renowned DeVilbiss Advance or FLG5 Spray Guns. DVP is perfect for use with ALL TYPES of Spray Gun technologies including, Conventional, Compliant TRANS-TECH®, HVLP and Electrostatic.

- Ideal for Spray Gun supply and material transfer applications
- Choice of cart, wall, pail & tripod mounted packages and outfits
- Rapid fluid delivery of up to 17 litres per minute
- Even surge free fluid delivery at up to 60 cycles / minute
- Designed specifically for spray finishing with quick flushing and fluid changes
- Twin air regulators provide independent control of pump and Spray Gun pressures
- Low capital cost compared to pressure tanks with no expensive pressure test certification regulations



DVP-610-F pail mounted 25 litre standard pump. \*Pail not included



DVP-630-F wall mounted standard pump



DVP-675 cart mounted standard pump



DVP-660 tripod mounted standard pump

DVP Pump specification and performance data	
Pump ratio	1:1
Max. regulated air supply pressure	7 bar (100 psi)
Max. fluid supply pressure	7 bar (100 psi)
Max. fluid viscosity (Ford No 4 cup)	60 seconds
Pump operating speed	60 cycles per minute
Fluid delivery rate	17 litres per minute (max)
Maximum fluid temperature	90 C (195 F)
Ambient temperature range	0° to 40°C
Air inlet	1/4"
Air outlet	1/4"
Fluid outlet	3/8"

DVP ready assembled spray outfits including spray gun part no's	
DVP-T-FLG5	Tripod mounted pump outfit with FLG5 gun
DVP-C-FLG5	Cart mounted pump outfit with FLG5 gun
DVPAN-T-ADV	Tripod mounted pump outfit with Advance TT gun
DVPAN-C-ADV	Cart mounted pump outfit with Advance TT gun



Advance Spray Gun



FLG5 Spray Gun

Binks DVP Pump Packages Part No's	
DVP-660	Tripod DVP standard pump
DVP-670	Tripod DVP waterborne pump
DVP-675	Cart mounted standard pump
DVP-685	Cart mounted waterborne pump
DVP-610-F*	25 litre pail standard pump
DVPS-F*	25 litre pail waterborne pump
DVP-630-F	Wall mounted standard pump
DVPE-F	Wall mounted waterborne pump
DVP-615*	25 litre pail ceramic pump
DVP-635	Wall mounted ceramic pump

\*Pail not included

Binks DVP Bare Pump Part No's:	
DVP-510	Standard/solvent paints
DVP-AN	Waterborne paints
DVP-515	Ceramic materials

Pump package contents and part numbers (excluding Spray Gun and Hoses)	DVP-660 TRIPOD	DVP-670 TRIPOD	DVP-675 CART	DVP-685 CART	DVP-610-F PAIL*	DVPS-F PAIL*	DVP-630-F WALL	DVPE-F WALL	DVP-615 PAIL*	DVP-635 WALL
Water and solvent based pump		●		●		●		●		
Solvent based pump	●		●		●		●			
Ceramic/abrasive material pump									●	●
Fluid filter bypass valve assembly	●	●	●	●	●	●	●	●		
Twin air regulators	●	●	●	●	●	●	●	●		●
Single air regulator									●	
Rigid St St suction tube and filter	●	●			●	●			●	
Flexible St St suction wand, filter and hose			●	●			●	●		●

1 Tips/needles = Stainless Steel as standard 2 Stainless Steel fluid passageways 3 Optional = Tungsten Carbide and hardened tips/needles 4 Substrate = Wood, metal, plastic and others 5 Substrate = Ceramic and glaze

# Electronic 2K Plural Component Paint Mixing Machine



2 4

The “cutting edge” 2K system for all types of applications. Magic Flow guarantees the accurate and reliable mixing and metering of two component materials.

### Universal 2K Electronic Mixing Unit

- Easy to Control with Repeatable Results
- Wide Field of Application
- Easy Installation and Commissioning
- Integrated Colour Change Sequencer
- Touch Screen Control
- Integrated VOC-Calculator
- Paint Level Control (up to 32 paints/colours)

Designed as a “Plug and Spray” machine, the Magic Flow is the best System to ensure repeatability whilst complying with the toughest EPA legislation. The mixing ratios can be stored in a wide range of up to 50 recipes and the icon guided touch screen allows easy communication between operator and machine. The precise dosing will always ensure a perfect finish. Magic Flow for all applications – including high and low pressure with solvent or water based paint and materials – Binks Magic Flow is the best solution.

FEATURES	
Suitable for	Solvent and water based paint
Mixing Ratio	0.5:1 to 50:1
Flow Rate	50 to 2.000 ml/min (other options upon request)
Working Temperature	10 – 70 C
Pressure Range	3 – 250 bar (Low-/High Pressure)
Viscosity	20 – 100.000 mm <sup>2</sup> /s
Fluid Section	Stainless Steel
Material Valves	32 max e.g. 28 colours, 2 solvents, 2 hardeners
Mode	Manual or Automatic
Options	Printer Port, Ex-Protection and Remote Control, mass flow meter, paint pressure regulation kit

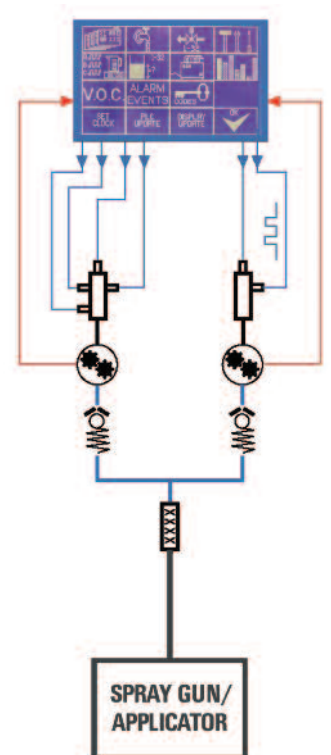

# Air/Fluid Hoses & Connectors

## Air and Fluid Hoses and Connectors (Low Pressure)

4 5

ITW hoses and connectors are purpose made for the spray finishing industry.

The use of the best and most dependable air and fluid hoses are vital to all finishing facilities to maintain optimum production levels with the minimum of maintenance downtime. By choosing ITW hoses and connectors you are assuring that your spray application equipment receives air and fluids in the best possible condition at the specified pressures and volumes. ITW hoses and connectors are manufactured to the highest quality to maintain engineering tolerances for maximum performance, durability and working life.

- Suitable for all low pressure finishing applications
- Approved for most industrial spray fluids
- Hoses include a conductive outer cover to comply with European ATEX and CE legislation
- Smoother outer cover ensures easy cleaning
- Flexible and manoeuvrable for decreased operator fatigue
- Hoses have excellent chemical compatibility
- Three piece reusable hose connectors (brass plated)
- Air and Fluid hose available per metre or delivered on 150m hose reels.
- Wide range of BSP & NPS threaded connectors



150m hose reels are available



Purpose made hoses and connectors for the spray industry with conductive outer cover.

### Choose hoses and connector part numbers from this specification chart:

Hose Pt No.	Description	Type	Bore size	Hose cover	Inner bore	Conductive	ATEX/CE	Max w.p.
H-7501	5/16" Bore AIR HOSE Red rubber	AIR	8	EPDM	EPDM	✓	✓	17bar (250psi)
H-7502	3/8" Bore AIR HOSE Red Rubber	AIR	9.5	EPDM	EPDM	✓	✓	17bar (250psi)
H-7503	1/4" Bore FLUID HOSE Black	FLUID	6	Nitrile	Nylon	✓	✓	34bar (500psi)
H-7504	3/8" Bore FLUID HOSE Black	FLUID	9.5	Nitrile	Nylon	✓	✓	34bar (500psi)
H-7501-150M	5/16" Bore Air Red Rubber (150M reel)	AIR (BULK)	8	EPDM	EPDM	✓	✓	17bar (250psi)
H-7502-150M	3/8" Bore Air Red Rubber (150M reel)	AIR (BULK)	9.5	EPDM	EPDM	✓	✓	17bar (250psi)
H-7503-150M	1/4" Bore Fluid Black (150M reel)	FLUID (BULK)	6	Nitrile	Nylon	✓	✓	34bar (500psi)
H-7504-150M	3/8" Bore Fluid Black (150M reel)	FLUID (BULK)	9.5	Nitrile	Nylon	✓	✓	34bar (500psi)

### 3 piece Re-usable Connections

Part no.	Bore	Connector	Part no.	Bore	Connector
PA-HC-4523	1/4" (6mm)	1/4" BSP	P-HC-4523	1/4" (6mm)	1/4" NPS
PA-HC-4527	5/16" (8mm)	1/4" BSP	P-HC-4527	5/16" (8mm)	1/4" NPS
PA-HC-4528	3/8" (9.5mm)	1/4" BSP	P-HC-4528	3/8" (9.5mm)	3/8" NPS
PA-HC-4543	1/4" (6mm)	3/8" BSP	P-HC-4543	1/4" (6mm)	3/8" NPS
PA-HC-4548	3/8" (9.5mm)	3/8" BSP	P-HC-4548	3/8" (9.5mm)	3/8" NPS

EPDM is (Ethylene Propylene Diene Monomer) rubber

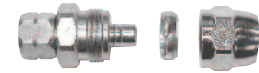

The above connectors are three piece re-usable (Plated brass)

### High Pressure Hose Assemblies (Airless)

Hose connectors: 1/4" NPS			
Length	Bore	Pressure max.	Part no.
1m	3/16"	350 bar	H-5811
7.5m	3/16"	350 bar	H-5813
7.5m	1/4"	310 bar	H-5818

## Quick Detach Fittings

Purpose made for a long and reliable life cycle

- Total convenience for air and fluid, quick detach reliable self-sealing
- High flow air connections - minimum pressure drop
- Ideal for all types of Spray Guns, Conventional, Compliant and HVLP
- Use them on Respirators, Hoses and Filter Regulators
- Four types available separately or in a set
- Fluid QDs made from Stainless Steel

4



### DeVilbiss Part no's (air)

MPV-5	Male Quick detach stem with 1/4" female fitting (fits Spray Gun inlets)
MPV-424	Female quick detach connection with 1/4" male fitting (fits hose ends)
MPV-10	Male quick detach stem with 1/4" female fitting
MPV-462	Female quick detach with 1/4" female fitting (fits filter regulator valves)
MPV-463	Economy pack includes 1 of each of the 4 shown above

### DeVilbiss/Hosco Part no's (fluid)

PA-HC-4482	Quick detach system - 3/8" BSP - Fluid
ODL-4808	QD Connection - Fluid
SSQD-6B-316	QD Connection SR 3/8" Male
SS-STEM-6B-316	QD Stem 3/8" Female
SS-STEM-6B-316HF	QD Stem high flow 3/8" Female

### Binks Part no's (fluid)

19 07 61	QD body assembly (hose end)
20 11 20	QD stem assembly (gun end) Stainless Steel



# Pressure Feed Containers

## Pressure Feed Containers

- Fully approved and CE marked to the latest pressure equipment directive 97/23/EC
- Constructed from Heavy Gauge steel with forged steel clamps
- Stainless Steel and Carbon Steel Plated range covers ALL industrial applications
- Higher pressure rating for Heavier materials
- Range offers complete material handling suitability for solvent and waterborne coatings
- Inner Liners reduce cleaning time and save coating material
- Top and Bottom outlet conversion kits available
- Single air regulator as standard with optional dual outlet kits.

Pressure feed containers are used to allow the coating material to be prepared, thinned and conditioned, constantly agitated (if required) and then supplied in bulk to consistently maintain the correct spraying viscosity and pressure. The Binks range is equipped with easy to operate air regulators (to set the desired fluid outlet pressure) safety pressure relief valves and Manual, Rotary or Oscillating agitation types are available to provide the best quality agitation. Binks Pressure Feed Containers are constructed from the highest grade materials and fully comply with European and Global pressure regulations including PED, ATEX and ASME.

Binks have a pressure tank to fit every industrial application:-

### Zinc Plated for Solvent-Based Coatings (10 litres)

Shown with optional twin air regulators.

4 5



### Stainless Steel Wetted Parts (10 litres)

Stainless Steel passageways for solvent and waterborne materials.

2 4 5



### Stainless Steel Construction throughout (10, 40 and 60 litre capacity)

For waterborne and solvent based materials.

2 4 5



### Galvanised Carbon Steel (40 litres)

For solvent based materials.

4 5



## Pressure Feed Containers - Accessories

Bottom outlet conversion kits #QMS-443 for 40 & 60 litre and QMS-435 for 10 litre St St tanks.

Air Regulator Kits - Pressure tanks are supplied with one air regulator as standard - Optional kits are available.

Model QMS-436	One gauge, one regulator. Converts single regulation to dual.
Model QMS-4006	One gauge, one regulator. Regulates and indicates tank pressure.
Model QMS-4007	Two gauges, two regulators. Controls tank pressure and atomisation air pressure to gun.

For further detailed pressure tank information please refer to the appropriate service bulletin.



**Note:** A disposable tank liner is supplied with all pressure tanks as standard. Replacement tank liner part numbers are:

10 litre (2.8 gal.)	PT-78-K10 or K60
40 litre (11.8 gal.)	PTL-412-K8
60 litre (19.8 gal.)	PTL-415-K10

When combined with the use of disposable liners, there is no more economical way to run a paint operation for most applications.



## Pressure Feed Containers / Pressure Feed Cups

### Pressure Feed Containers - Range and Specification

4 5

	Part No.	Capacity		Pressure Feed Tank - Construction type	Agitation	Agitator type*	Air inlet	Fluid outlet	Max. Pressure	
		Litres	US Gallon						bar	(psi)
Zinc Plated	83C-210	10	2.8	Zinc plated - Carbon Steel	No Agitation	None	1/4"	3/8"	5.5	80
	83C-211	10	2.8	Zinc plated - Carbon Steel	Direct Drive Rotary Agitation	D	1/4"	3/8"	5.5	80
Stainless "Wetted" Parts	83Z-210	10	2.8	Stainless Steel Lid and St St fluid passages	No Agitation	None	1/4"	3/8"	5.5	80
	83Z-211	10	2.8	Stainless Steel Lid and St St fluid passages	Direct Drive Rotary Agitation	D	1/4"	3/8"	5.5	80
Fully Stainless Steel	83S-210	10	2.8	Fully Stainless Steel - Electropolished	No Agitation	None	1/4"	3/8"	7.6	110
	83S-211	10	2.8	Fully Stainless Steel - Electropolished	Direct Drive Rotary Agitation	D	1/4"	3/8"	7.6	110
	83S-212	10	2.8	Fully Stainless Steel - Electropolished	Manual Agitation	Manual	1/4"	3/8"	7.6	110
	83S-213	10	2.8	Fully Stainless Steel - Electropolished	Gear Reduction Rotary Agitation	I	1/4"	3/8"	7.6	110
	83S-1010	40	11.8	Fully Stainless Steel - Electropolished	No Agitation	None	1/4"	3/8"	7.6	110
	83S-1013	40	11.8	Fully Stainless Steel - Electropolished	Gear Reduction Rotary Agitation	I	1/4"	3/8"	7.6	110
	83S-1016	40	11.8	Fully Stainless Steel - Electropolished	Reciprocating Agitation	R	1/4"	3/8"	7.6	110
Galvanised Steel	83G-1010	40	11.8	Galvanised Carbon Steel	No Agitation	None	1/4"	3/8"	7.6	110
	83G-1013	40	11.8	Galvanised Carbon Steel	Gear Reduction Rotary Agitation	I	1/4"	3/8"	7.6	110
	83G-1016	40	11.8	Galvanised Carbon Steel	Reciprocating Agitation	R	1/4"	3/8"	7.6	110
Fully Stainless Steel	83S-1510	60	19.8	Fully Stainless Steel - Electropolished	No agitation	None	1/4"	3/8"	7.6	110
	83S-1512	60	19.8	Fully Stainless Steel - Electropolished	Manual Agitation	Manual	1/4"	3/8"	7.6	110
	83S-1513	60	19.8	Fully Stainless Steel - Electropolished	Gear Reduction Rotary Agitation	I	1/4"	3/8"	7.6	110

\*Agitator types :-

- D** Direct Drive Agitator - Air powered direct drive agitator assembly with 1/2 hp air motor and a three blade propeller to keep materials in suspension even with high solids.
- I** Indirect Air Motor Drive - Standard duty, smooth running with gear reducer, 1/2 hp, 15:1 ratio, 20 to 120 RPM. Inc throttling valve, fittings and hose for connection to air supply on tank lid. Air consumption is approx 6CFM @ 50RPM.
- R** Reciprocating Air Motor Drive - 180° reciprocating action provides excellent agitation of all types of materials. Particularly important for waterborne shear sensitive materials. Very low air consumption.



Agitator type D



Agitator type I



Agitator type R

### KBII 2.3 Litre Remote Cup Standard – Aluminium & ST ST

2 4

Light weight, portable and easy to use

- 2.3 Litre capacity - greater area coverage, less refills
- Complete gun manoeuvrability at any angle
- Suitable for most Conventional or Compliant pressure/suction guns
- Stable, wide, reinforced base and fast, spin ring lid system
- **Aluminium** or **Stainless Steel** options (for waterbased materials)
- Familiar gun grip handle plus belt hook for operator convenience
- At-the-job controls with lid mounted pressure gauge
- Available complete with short cup to gun air and fluid hoses

The KB11 is a versatile pressure fed cup designed to give complete freedom of movement for the spray gun and the operator. Suitable for use with either conventional or compliant/HVLP pressure fed spray guns the cup can handle wide variety of paints and coating materials. Its generous 2.3 litre capacity dramatically reduces the need for constant cup refills. Using a remote cup means that the spray gun is lighter and can even be used upside down with total manoeuvrability in hard to reach areas.



Part no: KB-622-B Aluminium inc. hoses

Part no: KB-522-SSB Stainless Steel (no hoses)

KBII 2.3 Specification	
Air inlet and outlet connections threads	1/4" BSP(M)
Fluid outlet connection (to Spray Gun)	3/8" BSP(M)
Capacity	2.3 Litres (2 Quart)
Weight (less hoses and paint)	1.76 kg
Maximum working pressure	2 bar (30 psi)

## Pressure Feed Cups / Agitators

### Binks Steadi-Grip 2.3 Litre / 2 Quart Pressure Cup

4 5

Light weight, portable and easy to use

- 2 Quart/2.3 litre capacity - greater area coverage, less refills
- Complete gun manoeuvrability at any angle
- Suitable for most Conventional or Compliant pressure/suction guns
- Large "wide mouth" opening enables rapid filling and easy cleaning
- Cup features four lid clamps for quick and easy access
- Comfortable gun handle shaped carrying handle and belt hook for operator convenience
- Separate air control regulator and lid mounted pressure gauge
- anodised bright dipped Aluminium cup and "Silverstone" coating on lid interior and exterior

The Steadi-Grip is the most advanced pressure fed cup from Binks designed to give complete freedom of movement for the Spray Gun and the operator, in particular those working on production finishing lines. Conventional or Compliant/HVLP pressure fed Spray Guns can be used with Steadi-Grip and it is suitable for use with a wide variety of paints, enamels and other coating materials. Its 2 Quart/2.3 litre capacity dramatically reduces the need for constant cup refills. Using a remote cup means that the Spray Gun is lighter and can even be used upside down with total manoeuvrability in hard to reach areas.



Standard Cup Part no: 80-600  
Agitated Version Part no: 80-601

Steady-Grip 2.3 Specification	
Air inlet and outlet connections threads	1/4" NPS(M)
Fluid outlet connection (to spray gun)	3/8" NPS(M)
Capacity	2.3 Litres (2 Quart)
Weight (less hoses and paint)	4lbs 13 oz
Maximum working pressure	3.5 bar (50 psi)

### Binks air operated, rotary agitators and mixers

Designed for a wide variety of industrial and automotive applications. The agitators ensure paints and fluids are agitated precisely to keep paint solids in suspension and maintain optimum finishing characteristics. Binks agitators are suitable for a wide range of viscosities and paint material types including solvent based, waterborne and many other fluids.

Note: Binks recommend the use of an air oil lubricator with these air driven agitators.

### Binks Agitators, Drives and Covers for 25 litre (5 gallon) containers

4

#### Models 41-3312CE\* and 31-133CE\* for 25 litres (5 Gallon Pails)

- Furnished alone or as an assembly, mounted to container covers
  - Agitator and drive assembly only, standard
- Speed: Speed of propeller shaft is determined by fluid, 3000 RPM maximum  
Air Supply: Air supply to the motor should be 4 bar (60 psi) gauge pressure minimum

Model Number	41-3312CE*	31-133CE*
Includes	Agitator & Drive Agitator Drive	Assembly Only & Cover Assembly
Shaft/Propeller Material	Stainless Steel	Stainless Steel
Container Size	25 litre (5 Gallon) Pail	25 litre (5 Gallon) Pail
No. of Propellers or Paddles	1	1
Propeller/Paddle Diameter	79mm (31/8 in)	79mm (31/8 in)
Shaft Speed	To 3000 RPM	To 3000 RPM
Air Drive Type	Direct (HP:1/4) (CFM:10-14)	Direct (HP:1/4) (CFM:10-14)
Shipping Weight	6 kg (12 lbs)	16.6 kg (33 lbs)
Part Sheet Reference	77-1474	-



#### Model 41-3205

- Cover for open-top container
- Used for 25 litre (5-gallon) container
- For Pogo, Pogo B, and Transmatic
- Shipping Wt: 2.75 kg (5 1/2 lbs)
- Ref. Part Sheet: 77-1470



### Binks Hand Held Quick Mixers

4 5

For 25/50L and 200L containers

Part No.	Description
149-873	Variable speed, 1 propeller, 127mm diameter, shaft and propeller SS (shaft length 533mm)
149-874	Variable speed, 1 propeller, 127mm diameter, shaft and propeller SS (shaft length 1,016mm)

Note: These quick mixers are suitable for non ATEX areas only





## Binks Direct Drive Agitators for 205 litre (55 gallon) drums

4

Part No.	Description	
QS-574-H*	Rotary agitator assembly (S.S.) for 205L. Lid mounting. shaft length 1135mm.	Max air pressure 7 BAR
QS-575-H*	Rotary agitator assembly (S.S.) for 205L. Lid mounting. shaft length 900mm.	Max air pressure 7 BAR
QS-576-H*	Rotary agitator assembly (S.S.) for 205L. Lid mounting. shaft length 760mm.	Max air pressure 7 BAR

Note: Binks recommends the use of an oil lubricator with all air driven agitators.



Part no: QS-574-H rotary Agitator

## Binks Direct Drive Agitators and Drives for open top 205 litre (55 gallon) drums

### Model 41-3304 for 205 litre (55 Gallon) Drums

4

- Stainless Steel agitator and drive assembly only
- Speed:* Speed of propeller shaft is determined by fluid, 1000 RPM maximum
- Air Supply:* Air supply to the motor should be 4 bar (60 psi) gauge pressure minimum

Model Number: 41-3304			
Includes	Agitator & Drive	Shaft Speed	To 1000 RPM
	Assembly Only	Air Drive	Type: Direct
Material	Stainless Steel		HP: 1/4
Container Size	205 litre (55 Gallon Drum)		CFM: 10-14
No. of Propellers or Paddles	2	Shipping Weight	6 kg (12 lbs)
Propeller/Paddle Diameter	130mm (5 1/8 in) (SS)	Part Sheet Reference	77-1390



## Binks Gear Drive Agitator for heavy fluids in open top 205 litre (55 gallon) drums

4

### Model 31-397 Gear Drive Agitator (with cover)

- For open top 205 litre (55) gallon drums ● Gear drive, 40 RPM
- For heavier fluids such as paints and mastics furnished with:
  - 1/2 HP air motor (10 to 14 CFM)
  - Zinc Plated Clear Chromate cover (31-124)
  - Two 370mm (14 1/2 in. diameter Stainless Steel paddles with Stainless Steel shaft

*Speed:* Speed of the air motor is regulated by an air adjusting valve (part no. HAV-500). The speed of the agitator shaft below the reduction gear box should not run faster than 30 to 40 RPM maximum.

*Air Supply:* Air used to operate this unit should come directly from a high pressure source; do not use air that has passed through a regulator. Air supply to the motor should be a minimum of 4 bar (60 psi) gauge pressure.

Specification – Model Number: 31-397			
Container Size	205 litre (55 Gallon) Drum	Speed	30 to 40 RPM
Motor Specifications		Propeller Specifications	
Air Motor Model	Gear	Number of Props	2
HP	1/2	Diameter	370 mm (14.5 in)
CFM	10-14	Material	Stainless Steel
Shaft Specifications		Cover Specifications	
Mount	Flange	Model Number	31-124
Diameter	12.7 mm (1/2 in)	Size	205 litre (55 Gallon) Drum
		Material	Zinc Plated Clear Chromate Cover

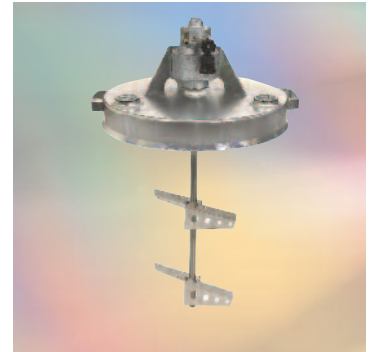

**Note:** Refer to the Agitator Service Bulletin for specific application details.

\* These Agitators are CE/ATEX Approved.

## Pneumatic Elevator

4

The Pneumatic Elevator uses a double-acting cylinder to power the elevator in both the up and down strokes. The unit includes an anti-twist device and a sturdy base stand with adjustable drum positioning feature. The lid arm has three height fixing positions.

Note: These models do not include actuation valve or lid/Drum as standard.

ATEX and CE approved.

Specification		
Part Number	PHV-550	PHV-1000
Stroke	550mm	1000mm
Max pressure	6 BAR	6 BAR
Lifting force	50kg	75kg

Optional accessories		
PHV-550-360	Lid for PHV-550	dia. 360mm
PHV-1000-610	Lid for PHV-1000	dia. 610mm
PHV-1000-5000	Manual operating valve for up and downward stroke and agitator.	

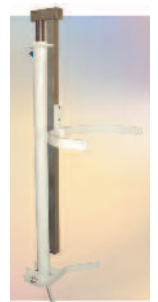

# Air Filter Regulators

## DVFR Advanced Air Management

- Genuinely high air flows for Conventional and Compliant/TRANS-TECH Spray Guns
- Rolling diaphragm for rapid response and precision control
- Optional filter specifications for spraying and air fed respiratory protection outfits
- Tough, heavy duty construction for long service life
- Multi-valved outlets for Spray Gun, Air Fed Mask and Air Tools plus semi-automatic filter drains
- Tamper proof, removable and lockable adjustment knobs

Compressed air is the lifeblood of every spray shop and it's effective management is vital to operator safety, efficiency and maintaining ultimate finish quality. The DeVilbiss DVFR range of air filter regulators and coalescers are manufactured using super resistant techno-polymer materials used in the construction of the filter bodies ensuring total solvent resistance, while the state of the art rolling diaphragm technology ensures optimum air flow and precision control.

## DVFR-1 Filter Regulator

4 5

This high capacity, 124 cfm, three outlet unit has been designed for use in and around the Spray Booth. Constructed using leading edge techno-polymer materials, the DVFR-1 is resistant to solvents.

Dual filtration eliminates dirt down to 5 microns from reaching the Spray Guns and like all DVFR filter regulators, condensate can be removed from the filter bowl manually or semi-automatically on depressurisation of the system.



Part No: DVFR-1

## DVFR-2 Filter Regulator Coalescer

4 5

- Ideal for operator 'breathing' air

The industry favourite is ideal for both industrial and heated "combi booths" Spray Booth's, it is mandatory for use with Air Fed Respiratory Protection.

Triple filtration removes dirt and other contaminants down to 0.01 microns, while the capacity of 124 cfm provides sufficient air flow to run two masks and two guns.



Part No: DVFR-2

## DVFR-3 Filter Regulator

4 5

This general purpose unit has been developed for both paintshop and general workshop applications.

The Dual filtration process eliminates dirt down to a particle size of 20 microns from air tools and Spray Guns, while the two ball valve controlled outlets have a total capacity of 60 cfm.



Part No: DVFR-3

## DVFR-4 Filter Regulator

4 5

This unit is designed for use with spray equipment, which requires filtered air at main line pressure, while the other outlet pressures can be regulated.

The unit has a generous capacity of 90 cfm and dual filtration down to a particle size of 5 microns.

Note: This unit is not suitable for use in a low bake spray booth.



Part No: DVFR-4

## Replacement Filter elements

4 5

In order to maintain optimum air quality, which is of vital importance when Air Fed Respiratory Equipment is being used, filters must be changed regularly. Three types of replacement filter element are available for particle sizes of 20, 5 and 0.01 microns.

Part no's
DV-9451705 Replacement 5 micron filter element for DVFR-1, DVFR-2 and DVFR-4
DV-9451711 Replacement 0.01 micron fine filter breathing element air for DVFR-2
DV-9351706 Replacement 20 micron filter element for DVFR-3



# Air Filter Regulators

Specifications	DVFR-1	DVFR-2*	DVFR-3	DVFR-4
Model	DVFR-1	DVFR-2*	DVFR-3	DVFR-4
Air Inlet Thread	1/2" BSP (F)	1/2" BSP (F)	1/2" BSP (F)	1/2" BSP (F)
Regulated Outlets	3 Valved	3 Valved	2 Valved	2 Valved + 1 Plugged
Unregulated Outlets	NA	NA	NA	1 Valved + 1 Plugged
Air Outlets (Ball Valves)	1/4" BSP (M)	1/4" BSP (M)	1/4" BSP (M)	1/4" BSP (M)
Width (Overall)	175mm (6.9")	240mm (9.5")	165mm (6.5")	290mm (11.5")
Height (Overall)	280mm (11")	280mm (11")	240mm (9.5")	280mm (11")
Weight	2500 gms (88 oz)	3200 gms (113 oz)	1341 gms (46 oz)	2950 gms (104 oz)
Capacity (Maximum Air Flow)	3500 l/min (124 cfm)	3500 l/min (124 cfm)	1698 l/min (60 cfm)	2550 l/min (90 cfm)
Maximum Air Inlet Pressure	13 bar (189 psi)	13 bar (189 psi)	13 bar (189 psi)	13 bar (189 psi)
Maximum Regulated Outlet Pressure	0-8 bar (0-116 psi)	0-8 bar (0-116 psi)	0-8 bar (0-116 psi)	0-8 bar (0-116 psi)
Maximum Operating Temperature	100 C (212 F)	100 C (212 F)	40 C (104 F)	40 C (104 F)
Pressure Gauge	0-11 bar (0-160 psi)	0-11 bar (0-160 psi)	0-11 bar (0-160 psi)	0-11 bar (0-160 psi)
Gauge Port	1/8" BSP (F)	1/8" BSP (F)	1/8" BSP (F)	1/8" BSP (F)
Air Filtration	Down to 5 microns	Down to 0.01 microns*	Down to 20 microns	Down to 5 microns
Drain Valve	Semi-Automatic	Semi-Automatic	Semi-Automatic	Semi-Automatic
Maximum Pressure Drop	5% of Inlet Pressure	10% of Inlet Pressure	5% of Inlet Pressure	5% of Inlet Pressure

\*Suitable for Breathing Air

## Finish Line – Air Filter Regulators and Coalescers 4 5

### FLFR-1 Filter Regulator

- Air filtration down to 20 microns
- High quality manufacture
- Air flow of 70cfm (at 7 bar – 100 psi inlet pressure)
- Lockable and removeable (tamperproof) control



### FLRC-1 Filter Regulator Coalescer

- Compact, low cost single operator Filter Regulator and Coalescer
- Filtration down to 0.01 microns suitable for Air Mask or Visor
- Not suitable for low back temperatures



### FLCF-1 Coalescing Filter

- A 3/8" (port size) coalescing (fine oil) filter
- Air filtration down to 0.01 microns (suitable for breathing Air-Fed Visors/Masks)
- Replaceable filter element
- Maximum working pressure 18 bar (260 psi)



### FLRCAC-1 Filter Regulator Coalescer with Activated Carbon Filter

- High efficiency filter designed to remove dirt, liquid oil and water from spraying and breathing air
- Filtration down to 0.01 microns plus activated carbon filter removing contaminants down to 0.003ppm



### Regulator Assemblies

Part No.	Description
FLFR-1	Single outlet filter regulator (70cfm)
FLCF-1	Coalescing (fine oil) filter (25cfm)
FLRC-1	Single outlet filter regulator coalescer
FLRCAC-1	Single outlet filter regulator with coalescer with activated carbon filter
9450102	Replacement filter element
XA-12	Replacement coalescing filter element
AC-12	Replacement activated carbon filter
9450802	Upper cover
9450301	Metal bowl
GA-319	Gauge

# Fluid Regulators

## Fluid Regulators

2 4

A complete range for all industrial applications.

- Highly accurate pressure settings with no pressure “creep”
- Minimum setting pressure below 0.25 bar (3.75 psi)
- Regulator body design reduces paint wastage during maintenance
- Fast disassembly and cleaning
- Fluid passages in 303 Stainless Steel as standard
- Compatible with solvent and waterborne paints and materials
- Manual or Automatic control
- Consistent fluid pressures maintained without fluctuation



Part no: 84-420

Designed and developed for use in the latest high-tech paint shops our range of Diaphragm Fluid Pressure Regulators are precision made to provide extreme accuracy of the fluid as it arrives at the Spray Gun and/or Applicator. The DeVilbiss fluid regulators with either manual or automatic control can be utilised with Diaphragm Pumps, Pressure Feed Tanks or any size of Paint Circulating System.



Part no: HGS-5222

Part no: 84-404

Part no: HGBR-609

Part no: HGB-509

Note: For ceramic applications contact ITW-IF

Type Model	Specification							
	Part number	Manual adjustment	Automatic Pneumatic adjustment	Inlet pressure mini/maxi bar (psi)	Outlet pressure mini/maxi bar (psi)	Fluid Flow maximum l/min	Fluid Inlet fitting	Fluid Outlet fitting
In line Regulator	HGB-509 (no gauge)	●		2 (29)/12.5 (181)	1 (14)/5 (72)	13	3/8 NPS	3/8 NPS
with gauge 1.2 Bar	HGB-609-1.2	●		1 (14)/8 (116)	0.15 (2)/1.2 (17)	8.3	3/8 NPS	3/8 NPS
with gauge 5 Bar	HGB-609-5	●		2 (29)/12.5 (181)	1 (14)/5 (72)	13	3/8 NPS	3/8 NPS
with gauge 9 Bar	HGB-609-9	●		3/15 (217)	3 (43)/9 (130)	13	3/8 NPS	3/8 NPS
	HGB-510-R1		●	2 (29)/15 (217)	0.5 (7)/15 (217)	13	F 1/4 BSP	F 1/4 BSP
	HGB-510-R2		●	1 (14)/15 (217)	0.15 (2)/7	10.5	F 1/4 BSP	F 1/4 BSP
	HGB-510-R4		●	1 (14)/15 (217)	0.15 (2)/4	6.5	F 1/4 BSP	F 1/4 BSP
	84-531		●	2 (29)/15 (217)	0.5 (7)/15 (217)	13		
Gun Mounted Regulator	HGS-5132		●	3.5 (50)/20 (290)	0.14 (2)/7 (101)	2.5	1/8 NPT	3/8 NPS
	HGS-5112		●	3.5 (50)/20 (290)	0.14 (2)/7 (101)	2.5	1/4 NPS	3/8 NPS
	HGS-5211	●		3.5 (50)/20 (290)	0.14 (2)/7 (101)	2.5	1/4 NPS	Bayonet
	HGS-5222	●		3.5 (50)/20 (290)	0.14 (2)/7 (101)	2.5	3/8 NPS	3/8 NPS
	HGS-5212	●		3.5 (50)/20 (290)	0.14 (2)/7 (101)	2.5	1/4 NPS	3/8 NPS
Back Pressure Valves	84-404	●		0.7 (10)/9.8 (142)	0.7 (10)/9.8 (142)	42	3/4 NPT (F)	3/4 NPT (F)
	HGBR-609	●		2 (29)/12.5 (181)	0.9 (130)	18	1/4 NPS/BSP	1/4 NPS/BSP
	84-601	●		9 (130)		3.7	1/2 NPT	1/2 NPT
HP in line regulator	84-420	●		206 (2987)	20.6 (298)/137.8 (1998)	3.7	1/4 NPT	1/4 NPT

## Air Fed Visors and Masks

### MPV-623 Integral Style Air-Fed Visor Outfit

4 5

- A single air line supplies breathing and spraying air
- Waistbelt incorporates odour filter and pre-set visor air regulator
- Visor is supplied with both foam and fabric face seal cassettes
- The visor is hinged with adjustable crown strap and ratchet headband
- DeVilbiss breathing systems are fully approved to EC directives and CE marked for total operator confidence



Part no: MPV-623 Complete face visor outfit.

The MPV Air-Fed Face Visor outfit provides the effective, practical and comfortable solution for operator respiratory protection.

### MPV-628 Economy Air Fed Visor Outfit

- Excludes accessories, gun hoses etc



Part no: MPV-628 Economy outfit.

### MPV-627 Air-Fed Half-Mask Breathing Outfit

4 5

- A single air line supplies breathing and spraying air
- One piece high specification goggles are included
- The facepiece incorporates dual exhalation valves and an air inter diffuser
- Waistbelt incorporates odour filter and pre-set visor air regulator
- Outfit includes high quality gun hose (1.2M x 8mm bore)



Part no: MPV-627 Complete face visor outfit

The MPV Air-Fed Half-Mask outfit remains a firm favourite with a large number of professional sprayers. The mask has a softer, more pliable face piece with a user-friendly headstrap cradle.

### MPV-629 Valuair – Half-Mask Respirator

4 5

- Lightweight, soft, pliable face piece
- Easy bayonet fitting filter cartridges
- Comfortable elasticated /moulded head strap cradle
- Replaceable A2 specification cartridges supplied as standard
- Pre-filters to extend the service life of the main filter cartridges

#### Specification – A2 Filters

A2 filters are for use against organic vapours with boiling points above 650°C. The Valuair mask with A2 filter cartridges can therefore be used in areas of contamination up to 10 x the Occupational Exposure levels set by the Health and Safety Executive.

Suitable for use with cellulose paints, primers, lacquers and varnishes but not suitable for use with Isocyanates. Assigned Protection Factor of 10.

Part no	Description
MPV-629	Valuair Cartridge Mask complete with A2 Filter cartridges and pre-filters
MPV-492	Pair of pre-filter covers plus ten filter pads
MPV-494-K2	Pack of two A2 specification filter cartridges
MPV-4006	One piece protective goggles for use with half masks



Part no: MPV-629 Valuair Half Mask Respirator

### MPV-496 Freedom – Half-Mask Respirator

4 5

- Lightweight, dual filter, semi-disposable Half Mask Respirator
- Can be used up to a maximum of 28 days
- Maintenance free and requires no spare parts
- Low nose bridge helps to accommodate goggles for optimum vision and safety
- Head strap has no buckles or fasteners and is comfortable and easy to use

#### Specification – A2 Filters

A2 filters are for use against organic vapours with boiling points above 650°C. The Freedom mask with A2 filter cartridges can therefore be used in areas of contamination up to 10 x the Occupational Exposure levels set by the Health and Safety Executive. Suitable for use with cellulose paints, primers, lacquers and varnishes but not suitable for use with Isocyanates. Assigned Protection Factor of 10.

Part no	Description
MPV-496	Freedom Cartridge Mask complete with A2 Filter cartridges
MPV-4006	One piece protective goggles for use with half masks



Part no: MPV-496 and MPV-497 Freedom Half Mask

### MPV-497 Freedom – Half-Mask Respirator (alternative to MPV-496)

- Disposable half mask
- Lightweight, soft pliable face piece
- Comfortable elasticised moulded head strap & cradle
- Excellent Visibility
- Protection filter factor A1B1E1K1 - Alternative to A2 specification
- Weight – only 265g

The MPV-497 is identical to the MPV-496 apart from the filtration specification type - It protects against organic and inorganic vapours, acid, ammonia and its derivatives, fine solid particles, liquids and aerosols. Moulded in thermoplastic it has an exceptionally comfortable facial seal and a low nosepiece for good vision. It is completely silicone free. Part no: MPV 497

Accessories

DeVilbiss Gun Mounted Paint Filters

- Prevents paint inclusions in the sprayed finish
- Superior Stainless Steel construction
- Suitable for solvent and waterborne paints and materials
- Competitive list price
- Includes THREE filter elements as standard (60, 112 and 280 micron)
- Universal female thread – fits onto all 3/8" threaded guns
- Accepts USA and French style filter elements

2 4



Part no: VSA-512 3/8" BSP Fluid Filter Assembly (Excludes gun)

The paint filter assembly has been specifically designed for use with all types of low pressure spray painting equipment and comes complete with a range of three styrene filter inserts as standard. The VSA-512 is manufactured from high grade Stainless Steel with "universal" 3/8" threads for easy use on both BSP and NPS threaded spray guns.

Part Number VSA-512

St St Gun mounted paint filter kit includes one of each filter screen (Green/Blue & White)

Gun Mounted Replacement Filters:-

VSA-3	Spare 60 Micron Green filter (.0024")
VSA-4	Spare 112 Micron Blue filter (.0046")
VSA-5	Spare 280 Micron White filter (.0125")

Gravity and Suction Cups and Spares

4 5



Gravity Feed Cups

Part No	Description
GFC-501	568ml (1 Pint) Acetal gravity cup for Advance/GTI/GFG
KGP-509-1	284ml (1/2 Pint) Nylon gravity cup for GFG
SRI-510	125ml Acetal gravity cup
SRI-42-K3	Pack of 3 cone filters
SRI-478-K12	Pack of 12, 125ml gravity cups for SRI
SRI-480-K3	Black cup and lid for UV paint
GFC-402	Lid assembly for GFC-501 gravity cup
KGP-401	Lid assembly for KGP-509 gravity cup
GFC-17-K5	Washer
GFC-2-K5	Pack of 5 drip check lids
KGP-5-K5	Pack of 5 gravity cup strainers for GFC-501 & KGP-509
SRI-8-K6	Pack of 6 lids for SRI gravity cups

Suction Feed Cups

Part No	Description
TGC-404-E	Cup Lid Assembly
TGC-407-1-K3	Valve kit of 3
TGC-9-K5	Lid Gasket - Kit of 5
KR-115-K5	Drip Free Diaphragm - Kit of 5
TGC-545-E-K	Complete Cup
KR-483-K10	Kit of 10 mesh KR cup strainers – to fit 7/16" tube, 115 Micron
KR-484-K10	Kit of 10 mesh KR cup strainers – to fit 7/16" tube, 350 Micron
KR-110-K3	Kit of 3 Spot Pots

Drip-Free Diaphragms

4 5

Prevents suction cup leaks and vent hole blockage.

- Allows the cup to be used at angles without fear of leakage
- Fits snugly under the cup lid - no need to remove the gasket
- Shallow wedge shape flows paint away from the vent hole
- Keeps a suction gun working smoothly



Part no: KR-115-K5 (Pack of 5)

Spray Gun Oil

4 5

Daily lubrication ensures a gun's long service life.

- Keep your Spray Gun in A1 working order
- A silicone-free lubricant has no affect to quality finishes
- Small, handy sachets to keep in the spares box



Part no: GL-1-K10 Kit of 10 sachets of spray gun oil

Cup Filters

4

Convenient, easy fit suction cup paint filters.

- Effectively removes dirt, flakes and scum
- Keeps the Spray Gun passages clear
- Inexpensive and virtually indestructible
- Resistant to most solvents easily cleaned
- Pushes onto the fluid tube of KR suction cups



Part no: KR-484 51 mesh filter screen (general purpose)

KR-483 130 mesh filter screen (finer filtration)

Gun Cleaning Brushes

4 5

Ideal for a variety of gun cleaning jobs.

- Tough, resilient bristles for useful service
- Correct size for cleaning most parts of the gun
- Ring ended for hook storage



Part no: 4900-5-1-K3 Pack of 3 brushes

Binks Disposable Pressure Tank Liners

4 5

- Enable quick colour changes
- Reduce solvent costs
- Reduce clean-up time
- Solve disposal problems
- Will not contaminate material

Custom made of tough, durable high-density Polyethylene for maximum performance. Includes Anti-Static additive to minimise static electricity build-up from the friction of shipping and handling liners.

When combined with the use of disposable liners, there is no more economical way to run a paint operation for most applications.



Replacement tank liner part numbers are:

10 litre (2.8 gal.)	PTL-78-K10 (10 pack) or K60 (60 pack)
40 litre (11.8 gal.)	PTL-412-K8 (8 pack)
60 litre (19.8 gal.)	PTL-415-K10 (10 pack)

**DGi Pro Digital Air Pressure Adjuster**

4 5

- Clear and Accurate DIGITAL Air Pressure Display
- Extremely accurate
- Easy to read
- Very tough
- Solvent resistant
- Zone 0 - Intrinsically safe
- Clear and easy to read, just squeeze the trigger and set



Part no: DGiPro-502-BAR

Provides accurate control of air pressures on Spray Guns, Paint Pumps, Pressure Tanks and many other finishing products and applications. The DGi Pro digital air pressure gauge by DeVilbiss is a 'Zone 0' approved digital air pressure gauge designed specifically for the Spray Finishing Industry. Engineered by DeVilbiss, the DGi Pro can even be put into the gun wash machine! Accurate and repeatable pressure settings to within .05 bar are assured with the smooth valve action. The DGi Pro is designed to have a service life of two years based on 24 hours a day continuous use.

**DeVilbiss "UNi" Swivel Fitting (Low Pressure)**

4 5

- Fits DeVilbiss/Binks and most other guns
- Reduces the risk of RSi
- Operator friendly - reduced "hose drag"
- Swivels and angles the Spray Guns



Part no: MPV-60 or MPV-60-K3 (pack of 3)

Avoiding repetitive strain injuries (RSi) is becoming more and more important in workshops and modern bodyshops. Whilst reducing the weight of spray guns and air tools has been a major help, DeVilbiss have introduced another way forward in combating the problem. This simple, practical accessory really helps to ease the weight of the hose and reduce fatigue when spraying. It angles as well as rotates so reducing hose drag and pull on the Spray Gun handle. It comes with a male quick-detach stem fitting to give instant, spannerless air hose fitting and has a 1/4" thread for gun or air tool attachment.

**Air Blow Gun**

4 5

Harness your compressed air for clean-up's.

- Lightweight
- Durable design
- Fitted with safety diffuser
- Low noise factor
- Lightweight



Part no: BG-4

**Mixing Cups**

4 5

Easy-to-use, disposable mixing cups.

- Handy, disposable, easy stacking mixing cups
- Made from solvent resistant clear polypropylene
- Permanently marked with 2:1, 3:1 and 4:1 mix ratios
- Calibrated with a 0-600 volumetric measurement scale



Part no: MC-1-K50 Pack of 50 cups

**VS-522 Fluid Strainer**

4

C/w 150 micron filter element as standard, for use with pressure tanks and low pressure diaphragm pump systems.

- Fits directly onto the Pressure Tank or Pump outlet
- Improves quality of paint finish by removing unwanted particles etc
- Brass/Nickel plated construction with nut and tail piece (3/8") for easy connection



Part no: VS-522  
Part no: VS-55 for replacement 150 micron nylon conical filter element

**In-Line Air Adjusting Valve**

4 5

Lightweight, at the gun pressure adjustment.

- Fits neatly in-line at the gun air inlet
- Ideal for setting up Compliant and HVLP Spray Guns
- Increase or decrease working pressure at-the-gun
- Loose swivel nut for convenient positioning
- Lightweight design (only 50 gms) does not affect balance
- 40mm diameter gauge in PSI and Bar
- Calibrated up to 11 Bar (160 PSI)



Part no: HAV-501

**Professional Spray Gun Cleaning Kit**

4 5

- Multi-purpose professional kit suitable for all Spray Guns
- Comprehensive range of brushes and tools
- Can be easily hung in the gun cleaning area
- Includes cleaning instructions and Spray Gun oil



Part no: KK 4584

**Viscosity Cups**

4

The fast, simple way to check out paint viscosity.

- Tough, durable, easy to clean Nylon
- Precision metal drain out insert
- Hanging hook for convenient storage
- No. 4 Ford Cup



Part no:7000-114-K2  
Pack of 2 viscosity cups

**Spot Pots**

4 5

- 0.5 litre capacity Nylon cup insert cuts down on costly paint mixes
- Tapered base ensures that minimal quantities of paint can be utilised
- Quickly and easily cleaned for frequent colour changes
- Fits all 1 litre capacity KR type suction cups



Part no: KR-110-K3

**Cup Filters**

4

Convenient, easy fit gravity cup paint filters.

- Eliminate the risk - fit a filter
- Fits snugly in the neck of the gravity feed cup
- Effectively removes dirt, flakes and scum
- Keeps the finish blemish free
- Inexpensive and virtually indestructible
- Resistant to most solvents and easily cleaned



Part no: KGP-5-K5  
Pack of 5 filters

**In-Line Air Filters**

4 5

Lightweight, gun mounting air filter.

- High efficiency action traps water, oil and dirt
- Incorporates multi-layered, high efficiency filter pads
- Minimal pressure drop and long service life
- Tough, solvent resistant Delrin® housing with 1/4" threads
- Lightweight design (only 50 grams) does not affect balance



Part no: HAF-507

## Accessories / Spares Kits

### Suction Cup Lid Gaskets

4 5

Ready to use, purpose fit suction cup lid seals.

- Choose between Tri-seal or traditional leather
- Handy packs of 3 replacement gaskets
- Fits all DeVilbiss KR type suction cups

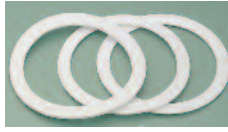

Part no's:  
KR-11-K3 Tri-seal gaskets.  
KR-69-K3 Leather gaskets

### Gravity Gun Stands

4 5

Stable metal workbench gun stands.

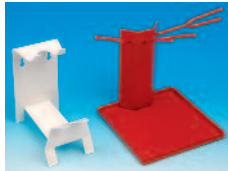

Part Number	Description
GFV-50F	Single gravity gun bench top stand
GGs-1	3 gun stand

### Mini-Filter (Fluid)

4

Stainless Steel final filter for all types of Spray Guns.

- Lightweight compact design
- Small internal volume – reduces paint wastage during cleaning/purging
- Fully Stainless Steel
- For use with waterborne and solvent based materials

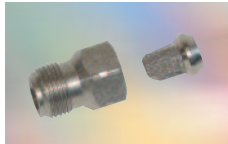

Part no: MF-6B-100B

Mini-Filter Pt No	Mesh size	Filter cartridge only	Thread
MF-6B-70B	200 micron	MFC-70	3/8" BSP
MF-6B-100B	149 micron	MFC-100	3/8" BSP
MF-6B-150B	100 micron	MFC-150	3/8" BSP
MF-6B-200B	74 micron	MFC-200	3/8" BSP

### Repair Kits (Air Regulator) for Pressure Cups and Tanks

4 5



Tank/Cup	Part Number	Description
KB-522-B	KK-4887-2	Remote Cup
80-600-CE	80-617	Steady-Grip Pressure Cup
83C-210 10L	KK-4977	Zinc Plated Pressure Tank
83Z-211 10L	KK-4977	ST ST Pressure Tank
83G-1013 40L	KK-4977	Galvanised Pressure Tank

Refer to Product Service Bulletin for more information.

### Service Kits DVP Diaphragm Pumps

4 5



DVP Type	Part Number	Description
DVP-510 / AN	KK-4630	Diaphragm and Pin
	KK-4631	Fluid valve for standard pump
	KK-4633	Reverse Switch Valve
	KK-4634	Pneumatic distribution kit
DVP-510	KK-4632	Fluid Valves for Ceramic Pump

### Spray Gun Service kits

4 5



### MANUAL SPRAY GUNS

Gun Type	Part Number	Description
JGA/JGV/GFG	KK-4558	Gasket & Seal Kit
	KK-4502-XX-H	General Service Kit incl. Tip and Needle
	KK-4585	Gun Maintenance Kit
Compact S,G,P	SPK-401-XX	General Service Kit incl. Tip and Needle
	SPK-402-K	Service Kit With Seals and Springs
Advance S,G,P	PRO-415-1	Spray Gun Service Kit
	GTI-428-K5	Seal and Pin Kit
GTi	GTI-416-XX	General Service Kit incl. Tip and Needle
Suction/Gravity	KK-4585	Gun Maintenance Kit
GTi Pressure	GTI-426-XX	General Service Kit incl. Tip and Needle
	KK-4585	Gun Maintenance Kit
EGA/EGHV	KK-5044	Gasket & Seal Kit
SRI Gravity	SRI-416	Gasket & Seal Kit
FLG-3 Gravity	FLG-488	Gasket & Seal Kit
FLG-5	K-5030	Baffle Replacement Kit
Gravity/Suction	K-5040	Repair kit - seals and springs inc. tool
	FLG-5 Pressure	K-5032
MSVAD-529	KK-5037-1	Gasket & Seal Kit
	KK-5040	Activator Valve Repair Kit
GFG HD/GTi HD/ JGA HD/PRI HD/	PRO-415-1	Spray Gun Repair Kit
	GTI-428-K5	Seal and Pin Kit

### AUTOMATIC SPRAY GUNS

Gun Type	Part Number	Description
AGF	KK-4514	General Service Kit incl. Tip and Needle
AGG	KK-4501	General Service Kit incl. Tip and Needle
AGN	KK-4998	Repair Kit
AGGS	KK-4566	General Service Kit incl. Tip and Needle
GTI-A	GTIA-406	General Service Kit incl. Tip and Needle
550	54-3121	Repair Kit
460	250035	Repair Kit
MAG AA	54-5307	Seal Kit
95A	54-3579	Repair Kit
COBRA 1	SPK-117	Seals
COBRA 2	SPK-118	Dynamic Seals - Viton Extreme
	SPK-109	Manifold Seals - Viton Extreme
AA4400A	SPK-119	Dynamic Seal Kit
	SPK-120	Needle Seal Kit
	SPK-121	Manifold Seal Kit

### AIRLESS AND AA SPRAY GUNS

Gun Type	Part Number	Description
Airless 1	6-236	Service Kit
AA1500	54-4970	Repair Kit
AA4000	54-4993	Repair Kit
HAP-50D	0114-013559	Seal Kit
	0114-013560	Repair Kit
HAP50F	0114-013560	Repair Kit



# Spray Booth Filter Paper

## Disposable Spraybooth Filter Paper

4 5

- Up to 98% filtration efficiency
- Outlasts other filters three to five times
- High loading capacity - longer working life - low pressure drop
- Expansion strapping ensures correct spacing of filter corrugations
- Filter marked at every foot for ease of cutting
- Concertina design reduces storage and transportation costs
- "Four face filtration"
- Bright white spray face - improves spraybooth lighting conditions.
- Stapled construction for strength and longer life
- Made at the Binks factory in Scotland

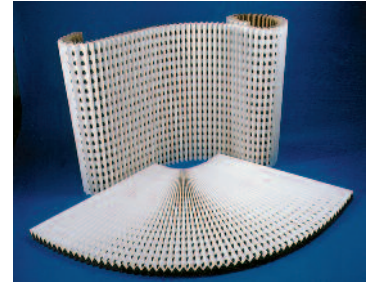

Binks disposable paper filter consists of 2 sheets of heavy cardboard paper formed into double accordion type folds with staggered holes to provide a highly efficient filter. Paint laden air is drawn into the filter by the Spray Booth fan and is forced to change direction four times causing particulate to adhere to the surfaces of the filter before exhausting to atmosphere. The large air openings in the filter allow high volumes of air to be exhausted without loss of efficiency as the media 'loads', resulting in a much longer life than other filter systems.



Technical Specification	
Filter Construction	Self supporting, two ply high strength cardboard paper. Bright white finish.
Air Flow Rates	100-200 feet per minute (0.5 - 1.0 metres per second) Normal 140 fpm (0.7 ms)
Pressure Differential	Initial @ 0.75 M/S = 30 PA (0.12" SWG) MAXIMUM 130-250 PA (0.52"-1.0" SWG)
Temperature Range	MAXIMUM 180°C (356°F)
Expansion Limiter	Expansion limiting straps ensure correct pleat guaranteeing optimum density of 8 corrugations per running foot (30.4cm)

Part no: 20 72 29	
Surface Area	10 sq yds
Filter Size Per Box	H90 x L924cm (H36" x L30ft)
Weight Per Box	10.5 kg (23lbs)

Part no: 20 79 01	
Surface Area	10 sq mtrs
Filter Size Per Box	H90 x L1115cm (H36" x L36ft)
Weight Per Box	12.6kg (28lbs)

Part no: 20 79 00	
Surface Area	10 sq mtrs
Filter Size Per Box	H75 x L1346cm (H30" x L44ft)
Weight Per Box	12.6kg (28lbs)

Part no: 20 79 02	
Surface Area	10 sq mtrs
Filter Size Per Box	H100 x L1038cm (H39" x L34ft)
Weight Per Box	12.6kg (28lbs)

## Binks SUPER FILTER – Super Efficiency spray booth filter paper

4 5

- Super Filter – Outlasts other filters
- Four Face Filter Technique PLUS additional "Final Stage" polyester filter
- Superior Construction – Glued and Stapled
- Over 99% filtration efficiency
- High Loading Capacity – Longer Working Life – Low pressure drop
- Fits ALL types of dry filter Spray Booths
- Expansion strapping – Ensures correct spacing of filter corrugations
- Moisture resistant and Self Supporting
- Concertina design – Reduces storage and transportation costs.

Binks Super Filter is constructed from two sheets of heavy duty cardboard paper and formed into double "accordion" type folds, stapled, glued and backed with a high efficiency polyester media, which dramatically increases the filter efficiency and "loading capacity".

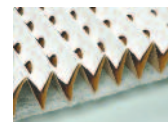
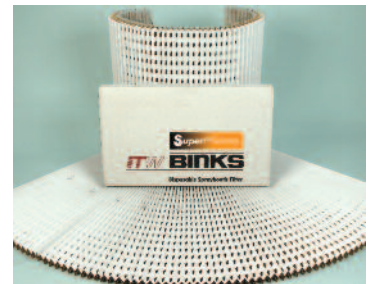

Technical Specification	
Filter Construction	Self supporting, 2 ply high strength cardboard paper. Bright white finish
Air Flow Rates	0.5-1.0 metres per second (100-200 feet per minute) Normal 0.7 m/s (140 FPM)
Pressure Differential	Initial @ 0.75 m/s = 30 Pa (0.12" SWG) Maximum 130-250 Pa (0.52"-1.0" SWG)
Temperature Range	MAXIMUM 100°C
Expansion Limiter	Expansion limiting straps ensure correct pleat
(Guarantees optimum performance)	Density of 8 corrugations per running foot (30.4cm)

Part no: 20 72 29 SEF	
Surface Area	5.4 sq mtrs
Filter Size Per Box	H90 x L600cm
Weight Per Box	8.05 kg (inc. box)

Part no: 20 79 02 SEF	
Surface Area	8 sq mtrs
Filter Size Per Box	H100 x L800cm
Weight Per Box	10.26 kg (inc. box)

**ITW Industrial Finishing conducts regular training courses for distributor personnel throughout the year in our fully equipped industrial training centre.**

The “modular” training courses cover all aspects and technologies used in the field of Industrial Spray Finishing. Delegates are able to gain valuable “hands-on” and “theoretical” experience with the advanced range of finishing products available, featuring the world renowned brands of Binks, DeVilbiss and Ransburg. Training is also provided on the industry specific health & Safety and statutory (ATEX/CE) requirements necessary in the demanding Spray Industry. The course agendas and dates are available on request.

**Training Program**

1 and 2 day courses are available for many different products and technologies and are customised for customers and our distributor personnel (Sales, Service & Technical).

Our professional trainers utilise the very latest training techniques and facilities to provide delegates with everything necessary to begin using and servicing our equipment. Upon completion of the modular training courses a professional training certificate will be presented to the delegates to confirm the specific training received.

Training modules include:	
P1	Manual Spray Guns
P2	Automatic Spray Guns
P3	Electrostatic Spray Guns
P4	Pump and Fluid Handling inc; Pressure tanks, Regulators and Agitators
P5	Plural Component 2K Magic Flow
R1	Electrostatic Gun Repair
R2	Pumps and Fluid Handling Repair
R3	Manual and Automatic Spray Gun repair (Conventional and TRANS-TECH/HVLP)



**Quality policy**

ITW Industrial Finishing continually strive to reliably deliver world class products that meet and exceed the expectations of our customers in respect of price, quality, innovation, performance, service and legal / regulatory requirements.

ITW Industrial Finishing is a global company operating through decentralised manufacturing units with a regional customer focus. Within the manufacturing scope of our business is a product range that extends from manually operated spray guns through to electrostatic spraying systems. Specific provision is made for products intended for use in potentially explosive atmospheres as defined within the Atex directive 94/9/EC in accordance with annex IV, by the implementation of BS EN 13980:2002 and is supplementary to the ISO9001:2000 Quality Management System.

Defining and measuring Quality Objectives as a result of planned reviews and audits forms the basis for continuous improvement of our business. New objectives can be implemented at any time and are directed through the organisation as appropriate.

## On-time Deliveries and Keeping you Informed

### Diamond and Sapphire Partners Europe

#### Unique commercial advantage

Diamond and Sapphire Partners are the highest level distributors and are our certified centres of excellence in your locality. A Diamond or Sapphire Partner provides the complete solution for all your finishing requirements. They are able to put the global resources of the company at your disposal and use the Company's wealth of experience in finishing technology to answer your problems and give you a unique commercial advantage. For the name and address of your nearest Diamond or Sapphire Partner please visit our website.



### Multilingual Literature and Product Service Bulletins

We produce a wide range of all encompassing multi-lingual literature covering all markets and applications. A detailed list of literature is available via the European web site [www.itwifeuro.com](http://www.itwifeuro.com) literature is also available by contacting us direct.

### Finishing Point

Finishing Point is our regular bulletin featuring customer's success stories for details contact your regional office. These are also available via the web site.

### GreenSpray

The focus throughout the company is to bring innovation to the Spray Finishing Industry with our Binks, DeVilbiss and Ransburg products. Through our new GreenSpray programme, that focus includes our efforts to conserve resources in the three core areas of the industrial finishing business.

- 1 Customer Operations
- 2 Product Design and Research
- 3 Corporate Operations



## www.itwifeuro.com

Binks, DeVilbiss, Ransburg Europe recently launched a new Product Finishing web site dedicated to provide finishing solutions for users operating in all application markets. The site has been built with multi-lingual options in English, French, German, Italian, Spanish, Russian, Turkish, Polish and Arabic. More languages are under construction. Visitors will find the web site extremely easy to navigate as the site has been constructed using all of the very latest high speed technology and will comply with recent legislation covering the DDA directive on accessibility for disabled people. The site is a dynamically controlled with products being stored in the sites database complete with reference to all technical documentation, service bulletins and literature. It is the intention to ensure this site is always kept up to date with recent news features, promotions and regular additions providing the latest information on Finishing Products and Services.



Product Service Bulletins are available from the multi-lingual web site [www.itwifeuro.com](http://www.itwifeuro.com)

**Finishing Brands**

Ringwood Road, Bournemouth, Dorset,  
England BH11 9LH  
Tel: +44 (0)1202 571111  
Fax: +44 (0)1202 573488  
Email: [marketing-uk@itwifueuro.com](mailto:marketing-uk@itwifueuro.com)

**Web: [www.itwifueuro.com](http://www.itwifueuro.com)**

Approved distributor: